

# Tracking California's Trash Project

## Testing Trash "Flux" Monitoring Methods in Flowing Water Bodies

State Water Resources Control Board Grant Agreement No. 12-420-550

---

Prepared for:

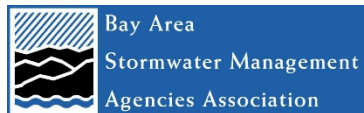

Prepared by:



5GYRES

3131 Olympic Blvd #302  
Santa Monica, CA 90404

December 2016

Funding for this project has been provided in full or in part through an agreement with the State Water Resources Control Board. The contents of this document do not necessarily reflect the views and policies of the State Water Resources Control Board, nor does mention of trade names or commercial products constitute endorsement or recommendation for use.

# TABLE OF CONTENTS

TABLE OF CONTENTS .....	ii
List of Tables .....	iv
List of Figures .....	iv
List of Appendices .....	v
Terminology .....	vi
<b>1. Introduction .....</b>	<b>7</b>
1.2 Definition of Trash .....	7
1.3 Monitoring Program Objectives .....	8
1.4 Literature Review and Recent Related Studies .....	8
1.5 Technical Advisory Committee .....	9
<b>2. Monitoring Design and Methods .....</b>	<b>10</b>
2.1 Methods Selection .....	10
2.2 Sampling Locations .....	10
2.2.1 Colma Creek .....	14
2.2.2 Coyote Creek .....	15
2.2.3 San Mateo Creek .....	16
2.2.4 Arroyo Seco .....	17
2.3 Monitoring Methods .....	18
2.3.1 Manta Trawl .....	22
2.3.2 High Speed Trawl.....	23
.....	23
2.3.3 Mini High Speed Trawl .....	24
2.3.4 Rectangular Trawl and Weighted Boxy Trawl .....	25
2.3.5 Other Equipment Analyzed .....	26
2.5 Quality Assurance and Control Procedures.....	27
<b>3. Sampling Requirements.....</b>	<b>28</b>
3.1 Permitting .....	28
3.2 Mobilization.....	30
3.3 Storm and Creek Monitoring .....	32
3.4 Sample Characterization .....	33
3.5 Weather Forecasting and Rainfall.....	34
3.6 Recording Flow .....	35
<b>4. Monitoring Results and Discussion .....</b>	<b>36</b>
4.1 Quality Assurance .....	36
4.2 Overview of Results .....	38
4.3 Calculated Trash Rates .....	40
4.3.1 Colma Creek .....	42
4.3.2 Coyote Creek .....	44
4.3.3 San Mateo Creek .....	46

4.3.4 Arroyo Seco .....	48
<b>4.4 Trash Load Estimates.....</b>	<b>50</b>
<b>4.5 Variability of Trash Throughout the Water Column .....</b>	<b>51</b>
<b>4.6 Equipment Feasibility.....</b>	<b>53</b>
<b>4.7 Weather and Flow Data .....</b>	<b>56</b>
<b>4.8 Project Costs .....</b>	<b>56</b>
<b>5. Conclusions and Information Gaps .....</b>	<b>59</b>
5.1 Sampling Equipment .....	59
5.2 Monitoring Site Considerations .....	59
5.3 Measuring Trash Rates and Loads .....	60
5.4 Timing and Sampling Considerations.....	60
5.5 Resource Considerations .....	61
<b>6. Recommendations .....</b>	<b>62</b>
<b>7. References .....</b>	<b>65</b>

## LIST OF TABLES

TABLE 1. CONSIDERED AND SELECTED (HIGHLIGHTED IN BLUE) RECEIVING WATER MONITORING SITES IN BAY AREA AND LOS ANGELES REGIONS. ....	11
TABLE 2. ESTIMATED TIMES THAT EACH TRAWL SHOULD BE DEPLOYED .....	21
TABLE 3. DETAILS RELATED TO PERMITS REQUIRED FOR EACH MONITORING SITE .....	30
TABLE 4. PROPOSED RECEIVING WATER MONITORING SITES AND WATER BODY TYPE .....	32
TABLE 5. CHARACTERIZATION DATA IN VOLUME FOR THE MONITORED STORM ON COLMA CREEK NOVEMBER 24, 2015 .....	34
TABLE 6. WEBSITES TO MONITOR WEATHER FORECASTS .....	35
TABLE 7. MONITORING LOCATIONS, DATE, EQUIPMENT USED, AND RAINFALL.....	39
TABLE 8. TRASH RATE AND DISCHARGE RESULTS FOR COLMA CREEK MONITORING EVENTS .....	43
TABLE 9. TRASH RATE AND DISCHARGE FOR COYOTE CREEK MONITORING EVENT.....	45
TABLE 10. TRASH RATE AND DISCHARGE RESULTS FOR SAN MATEO CREEK MONITORING EVENTS .....	47
TABLE 11. TRASH RATE AND DISCHARGE RESULTS FOR ARROYO SECO MONITORING EVENTS .....	49
TABLE 12. EFFECTIVENESS OF TRAWLS WITH USGS CRANE SYSTEM.....	53
TABLE 13. VELOCITY RANGE FOR EACH MONITORING EVENT .....	54
TABLE 14. ESTIMATED % OF TIME SPENT ON DIFFERENT ASPECTS OF THE TCT PROJECT .....	57
TABLE 15. ESTIMATED HOURS PER CATEGORY FOR PROJECT DATA COORDINATOR .....	57

## LIST OF FIGURES

FIGURE 1. MONITORING SITES AND USGS GAUGE LOCATIONS INCLUDED IN TCT PROJECT IN THE SAN FRANCISCO BAY AREA .....	12
FIGURE 2. MONITORING SITE AND USGS GAUGE LOCATION INCLUDED IN TCT PROJECT IN THE LOS ANGELES AREA (PASADENA) .....	13
FIGURE 3. TCT MONITORING LOCATION AND FLOW GAUGE LOCATION AT COLMA CREEK (SOUTH SAN FRANCISCO).....	14
FIGURE 4. TCT MONITORING LOCATION AT COYOTE CREEK (SAN JOSE) .....	15
FIGURE 5. MONITORING LOCATION AT SAN MATEO CREEK (SAN MATEO) .....	16
FIGURE 6. MONITORING LOCATION AT ARROYO SECO (PASADENA) .....	17
FIGURE 7. PHOTO OF USGS CRANE AT ARROYO SECO IN PASADENA, CA .....	18
FIGURE 8. PHOTO OF FIELD TEAM NEXT TO USGS CRANE AT SAN MATEO CREEK .....	19
FIGURE 9. MANTA TRAWL BRING DEPLOYED AT SAN MATEO CREEK.....	20
FIGURE 10. RECTANGULAR TRAWL WITH FLOW METER ATTACHED AT SAN MATEO CREEK .....	20
FIGURE 11. MANTA TRAWL PHOTOGRAPH AND SKETCH WITH DIMENSIONS .....	22
FIGURE 12. HIGH SPEED TRAWL PHOTOGRAPH AND SKETCH.....	23
FIGURE 13. MINI HIGH SPEED TRAWL PHOTO AND SKETCH WITH DIMENSIONS.....	24
FIGURE 14. PHOTOGRAPH OF 5 GYRES RESEARCH DIRECTOR MARCUS ERIKSEN HOLDING THE RECTANGULAR TRAWL (SILVER) AND WEIGHTED BOXY TRAWL (BLUE) AND SKETCH WITH DIMENSIONS. ....	25
FIGURE 15. STREAMBED SAMPLER PHOTOGRAPH AND SKETCH.....	26
FIGURE 16. FLOWCHART OF THE PERMITTING PROCESS FOR THE TCT PROJECT.....	29
FIGURE 17. TRANSPORTATION OF TRAWLS AND FIELD EQUIPMENT BY TRUCK TO ARROYO SECO FROM SAN FRANCISCO .....	31
FIGURE 18. TRAFFIC CONTROL MEASURES AT COLMA CREEK (CONES AND SIGNAGE).....	32
FIGURE 19. PIE CHART FOR TRASH CATEGORIZED BY MATERIAL FOR ALL SAMPLES COLLECTED (BY VOLUME) .....	40
FIGURE 20. BOXPLOT OF WET AND DRY EVENT TRASH RATES FOR EACH MONITORING EVENT .....	42
FIGURE 21. TRASH RATES, FLOW, AND PRECIPITATION AT THE EVENT ON COLMA CREEK NOVEMBER 24, 2015.....	44
FIGURE 22. TRASH RATES, FLOW, AND PRECIPITATION AT THE EVENT ON COYOTE CREEK MAY 6, 2016.....	46
FIGURE 23. TRASH RATES, FLOW, AND PRECIPITATION AT THE EVENT ON SAN MATEO CREEK FEBRUARY 17, 2016.....	48
FIGURE 24. TRASH RATES, FLOW, AND PRECIPITATION AT THE EVENTS ON ARROYO SECO MARCH 6-8, 2016 .....	50
FIGURE 26. WEIGHTED RECTANGULAR TRAWL AFTER RETRIEVAL AT ARROYO SECO.....	52
FIGURE 27. RECTANGULAR TRAWL DEPLOYED AT SAN MATEO CREEK .....	55
FIGURE 28. SKETCH OF SUGGESTED IMPROVED BOOM TRUCK WITH CRANE AND WEIGHTS.....	63

## **LIST OF APPENDICES**

**APPENDIX A: PERMITS AND TRAFFIC CONTROL PLANS**

**APPENDIX B: CHARACTERIZATION DATA AND FIELD SHEETS**

**APPENDIX C: DATA QUALITY ASSURANCE EVALUATION**

**APPENDIX D: ADDITIONAL PHOTOGRAPHS**

## TERMINOLOGY

**Debris:** Natural, not man-made, material, including vegetation and sediment. This does not include trash.

**Dry Weather Event:** An event where less than 0.25 inches of rain occurred in a 24 hour period within 48 hours prior to the sampling event.

**Wet Weather Event:** An event where 0.25 inches of rain or greater occurred in a 24 hour period within 48 hours prior to the sampling event.

**Trash:** Trash includes litter as defined by the California Government Code, but excludes sediments, sand, vegetation, oil and grease, and exotic species that cannot pass through a 5 mm mesh screen. As defined by California Government Code Section 68055.1(g), litter means all improperly discarded waste material, including, but not limited to, convenience food, beverage, and other product packages or containers constructed of steel, aluminum, glass, paper, plastic, and other natural and synthetic materials, thrown or deposited on the lands and waters of the state, but not including the properly discarded waste of the primary processing of agriculture, mining, logging, sawmilling or manufacturing.

**Trash Rate:** Trash rates were calculated for each sample, and this rate was extrapolated using the calculated flow through the net and the discharge of the creek during the same period. Values are in gallons of trash per minute.

**Trash Load:** Trash load is the amount of trash that travels down receiving waters during a specific period. Trash loads can either measured in the sample, calculated for the entire creek during each sampling period, or calculated for a storm using all the samples in in the sampling event. Trash loads are usually in gallons, but also can be in pounds or number of items.

# 1. INTRODUCTION

The State of California has placed a high priority on the development and adoption of Total Maximum Daily Loads (TMDLs), National Pollutant Discharge Elimination System (NPDES) permit requirements and other policies designed to significantly reduce the levels of trash in creeks, rivers, lakes, bays and estuaries. Prioritization has spawned the development of baseline trash loading studies from stormwater and the implementation of enhanced control measures to reduce trash impacts in the Los Angeles Area, San Francisco Bay Area, and other regions in the State. Information on the costs and benefits of these control measures, however, is limited and monitoring methodologies needed to accurately measure progress towards TMDL or NPDES permit reduction goals need further testing and evaluation.

In 2013, the Bay Area Stormwater Management Agencies Association (BASMAA) was awarded a grant by the State Water Resources Control Board (State Water Board) to implement the Tracking California's Trash (TCT) project. The TCT project was designed to improve our collective knowledge about California's water quality concerns associated with trash and inform the actions that regulators, public agencies, and the concerned public can take to effectively resolve these concerns. Project outputs include the development of rigorous and repeatable trash monitoring methods, an assessment of the effectiveness and costs/benefits of specific trash control measures, and the development of a web-based portal that disseminates related information and recommendations to the public.

Specifically, the TCT project consists of three major tasks:

1. Testing Trash Trends Monitoring Methods for:
  - a. *Trash in Flowing Receiving Waters*
  - b. *On-land Visual Trash Assessments*
2. Evaluating the Effectiveness and Costs of Trash Control Measures
3. Developing a Web-based Portal to Disseminate Related Information

This report describes the results and conclusions of Task #1a, *Testing Monitoring Methods for Trash in Flowing Receiving Waters*. The study design and sampling and analysis methods was previously described in the Project's Monitoring Plan, submitted to the State Water Resources Control Board (State Water Board) in April 2014 (Geosyntec and EOA 2014) and the Sampling and Analysis Plan (SAP) submitted to the State Water Board in December 2014 (Geosyntec et al. 2014). The detailed monitoring study design included in the SAP and described in this report was based on input from the Project's Technical Advisory Committee (TAC) members<sup>1</sup> and a review of worldwide literature on methods previously used by researchers to measure the levels of trash in flowing water bodies during low and high flow events.

## 1.2 Definition of Trash

Litter (synonymous with trash) is defined in the California Government Code [Title 7.9. Recycling, Resource Recovery, and Litter Prevention, Section 68055.1(g)] as follows:

“Litter means all improperly discarded waste material, including, but not limited to, convenience food, beverage, and other product packages or containers constructed of steel, aluminum, glass, paper,

---

<sup>1</sup> TAC members include Dr. Robert Pitt (University of Alabama), Dr. Eric Stein (Southern California Coastal Water Research Project), Charlie Moore (Algalita Marine Research Foundation), and staff from the (State Water Resources Control Board), who are technical and scientific experts in the fields of stormwater control measure performance monitoring and trash monitoring/management. TAC members provided expert technical and scientific guidance on the design of the studies conducted via the TCT project.



plastic, and other natural and synthetic materials, thrown or deposited on the lands and waters of the state, but not including the properly discarded waste of the primary processing of agriculture, mining, logging, sawmilling or manufacturing."

For the purposes of the TCT project, trash includes litter as defined by the California Government Code, but excludes sediments, sand, vegetation, oil and grease, exotic species and litter that cannot pass through a 5mm mesh screen.

### **1.3 Monitoring Program Objectives**

The primary goal of the receiving waters monitoring component of the TCT project was to test monitoring methods designed to empirically measure trash concentrations and loading in flowing water bodies (e.g., rivers, creeks, and channels) in a standardized and reproducible manner during low and high flow events (i.e., trash flux). All monitoring methods tested were selected to allow trash concentrations and loads between sites to be compared, and for technology transfer to other areas in California and the U.S.

Monitoring methods were evaluated at sites located in four water bodies in the San Francisco Bay and the Los Angeles areas. Methods selected for evaluation and monitoring were based on the Project's literature review (EOA and 5 Gyres 2014) and through input from a Technical and Advisory Committee (TAC). Monitoring methods evaluated were informed by previous pilot research conducted by the 5-Gyres Institute, Algalita Marine Research Foundation, National Oceanic and Atmospheric Administration (NOAA), the California Department of Transportation, and BASMAA.

The receiving water monitoring component was designed to answer the following questions:

- What type of sampling equipment provides for the most accurate and representative measurements of surface, water column and bedload flux in the different channel types and sizes of flow events?
- What is the variability in trash loading within and among storms, and is there a first flush effect (seasonally and during each storm)?
- How much time and resources are required to conduct receiving water flux monitoring (sample collection and characterization)?

### **1.4 Literature Review and Recent Related Studies**

A literature review was carried out to analyze existing methods and projects that monitored trash within water bodies (EOA and 5 Gyres 2014). The review found that few municipalities and entities in the U.S. have attempted to evaluate concentrations and loads of trash discharged in receiving waters. The biggest source of references was from studies designed to monitor plastic pollution in marine environments, mostly at sea. Different methods and equipment have been used to varying degrees of success. Through a review of the worldwide literature, methods previously used by researchers to measure trash flux in receiving waters were documented and summarized in the project literature review report.

Methods used during the project were based primarily on NOAA's Marine Debris Monitor and Assessment Document (Lippiatt et al. 2013), Algalita's River Los Angeles Study (Moore et al. 2011) and 5 Gyres' global estimate that compiled data from multiple partners to determine a global estimate for plastic pollution (Eriksen et al. 2014). These studies suggested that using multiple trawls to capture samples of plastic pollution floating on the surface of a water body, with some focus on what is in the water column, would be the most successful approach for the TCT project. Therefore, methods described in these studies were

modified to capture trash samples in receiving waters to accommodate for the higher flows observed in rivers, creeks and channels during wet weather events.

Since the TCT Literature Review was completed in fall 2014, the USGS (Baldwin et al, 2016), San Francisco Estuary Institute (Sutton et al. 2015), and University of Maryland (Yonkos et al. 2014) have conducted additional noteworthy research. Each of these research projects focused on smaller fractions of trash (e.g., microplastics), but the techniques used were similar to those used in the TCT project. Baldwin et al (2016) used similar techniques to the TCT project, including a rectangular trawl to collect samples. The tributaries entering the Great Lakes Region are smaller and generally not channelized making sample collection much easier because of lower flow velocities. The study also looked at a smaller size fraction but the techniques used are relevant. The scientists involved in this project may be valuable resources for future trash monitoring research.

Adventurers and Scientists for Conservation (ASC), a nonprofit that focuses on linking travelers with citizen science had embarked on a large-scale project to document microplastics (specifically microfibers) in the environment, both in fresh and marine environments.<sup>2</sup> This project is a good reference if citizen science is incorporated into future receiving water monitoring.

## 1.5 Technical Advisory Committee

In early 2014, a Monitoring Technical Advisory Committee (TAC) was formed to assist with development of the TCT Project Monitoring Plan and SAP. On August 20, 2014, the TAC met to discuss the details of the TCT SAP, focusing on equipment designs and monitoring sites related to the project. The team discussed details about the TAC's role, the project overview (tasks, project impetus, project schedule), and an overview of SAP for on-land and in-stream monitoring sites/areas. Much of the meeting was also for the TAC to provide feedback about the study design.

The TAC's role throughout the project was to advise and give guidance and focus to the project. This was done through two TAC meetings, before and after fieldwork. In addition, TAC members were available to discuss problems and provided suggestions on appropriate sites that were monitored.

Input from the August 20, 2014 TAC meeting was essential in aligning project goals with proposed fieldwork. Based on input from the TAC, the types of trawls and techniques to sample trash were scaled back to focus on those that would help answer specific monitoring questions. Sampling with hand nets and tow trucks, two methods that were projected to be difficult in planning and implementing safely, were removed from consideration. The TAC also suggested that the project focus on the importance of developing and assessing the possibility of monitoring trash at different sections and depths in receiving waters. It was also suggested that the project focus on smaller events to understand trash throughout events, with the purpose of determining the most appropriate timing for sampling a storm (beginning, middle or towards the end of a storm).

The TAC also met and reviewed all results related to the TCT Project on November 16, 2016. In this meeting, the TAC provided feedback on analyses and how to effectively display data results in the final report.

---

<sup>2</sup> <http://www.adventurescience.org/microplastics.html>.

## 2. MONITORING DESIGN AND METHODS

### 2.1 Methods Selection

Methods selection was based on an extensive Literature Review (EOA and 5 Gyres, 2014), input from researchers and experts in the field including the TAC, and is described fully in the TCT SAP (Geosyntec et al. 2014). Common methods to monitor plastic pollution and trash identified by the TCT Literature Review, but since there was no project to directly base the methods on, the project pulled from multiple sources and developed new protocols to be tested. Additional experts in the field were asked about proposed techniques and methods more commonly used in marine environments and modified them for use in receiving waters.<sup>3</sup>

### 2.2 Sampling Locations

A total of 12 locations (Table 1) were identified as potential receiving water monitoring sites by the project team and local experts. The sites were selected from discussions with project management team, project partners, information provided by San Francisco Estuary Institute (SFEI), including a document that was used to evaluate rivers for potential sediment flux monitoring, USGS scientists and related ongoing research, and other experts from San Francisco Bay Area and the Los Angeles Area. The SAP contains a complete list of the potential receiving water monitoring sites evaluated.

5 Gyres staff evaluated each proposed monitoring site in April and May 2014 to evaluate whether each met the following criteria:

- Monitoring sites shall have perennial flow to facilitate dry season monitoring.
- Locations represent a range of channel types (e.g., channelized, natural channel) and sizes, as different types of equipment are appropriate for monitoring for different channel sizes.
- Each site shall have a bridgeway above the water body wide enough to safely deploy equipment.
- Consideration of upstream sources (e.g., homeless encampments, illegal dumping sites, on-land sources).
- Sites that have active flow gauges maintained by USGS or a water district are preferred to access flow monitoring data.

Based on site visits, listed in Table 1, and input from the project team and stakeholders, four monitoring sites were selected (highlighted in Blue). The locations of these sites are illustrated in Figures 1 and 2.

---

<sup>3</sup> Dr. Sherri Mason, Professor at State University of New York at Fredonia; Dr. Chelsea Rochman, Assistant Professor at University of Toronto; Lester McKee, Senior Scientist at SFEI; Austin Baldwin, USGS Wisconsin Water Science Center

**Table 1.** Considered and selected (highlighted in blue) receiving water monitoring sites in Bay Area and Los Angeles Regions.

Region	Receiving Water	Water Body Type	City	Coordinates for Preliminary Site Locations
	Colma Creek	Small Channelized Creek	South San Francisco	37.653326, -122.42586
	Coyote Creek	Large Riparian Creek	San Jose	37.380376, -121.900245
	Matadero Creek	Small Channelized Creek	Palo Alto	37.422205, -122.135792
	San Francisquito Creek	Small Riparian Creek	Palo Alto	37.457922, -122.142135
	San Mateo Creek	Small Riparian Creek	San Mateo	37.572638, -122.310769
	Sunnyvale East Channel	Small Channelized Creek	Sunnyvale	37.394728, -122.010441
	Zone 4 – Line A	Small Channelized Creek	Hayward	37.666597, -122.147228
Los Angeles Area	Arroyo Seco	Large Riparian Creek	Pasadena	34.146986, -118.163296
	Ballona Creek	Large Channelized River	Culver City	33.990571, -118.410376
	Coyote Creek	Large Channelized Creek	La Habra	33.924728, -117.956836
	Los Angeles River	Large Channelized River	Long Beach	33.840422, -118.203728
	San Gabriel River (North Fork)	Large Channelized River	Santa Fe Springs	33.916951, -118.038241

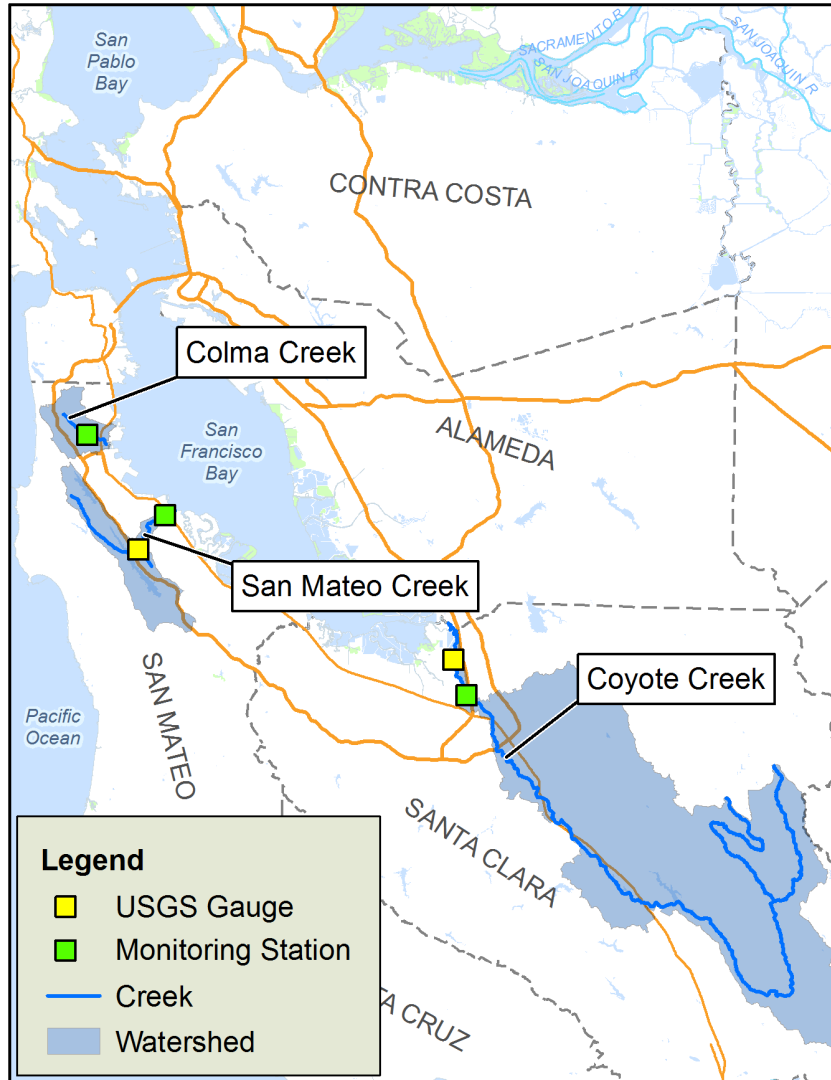

Figure 1. Monitoring Sites and USGS Gauge locations included in TCT Project in the San Francisco Bay Area



Figure 2. Monitoring Site and USGS Gauge location included in TCT Project in the Los Angeles Area (Pasadena)

### 2.2.1 Colma Creek

Colma Creek is a small channelized creek in the City of South San Francisco that extends from the San Bruno Mountains to the San Francisco Bay (Figure 1). The Colma Creek watershed is approximately 16.6 square miles and is mostly urbanized with a mix of residential, commercial and industrial land uses.<sup>4</sup>

The site monitored on Colma Creek is located at West Orange Avenue, just south of North Canal Street (Figure 3). Monitoring equipment was deployed from the eastern side of the bridgeway where the creek is a 25-foot wide concrete trapezoidal channel. There are two storm drain outfalls entering Colma Creek at this location.

The City of South San Francisco manages two flow gauges on Colma Creek. The Upper Colma Creek Gauge is located directly upstream of the TCT sampling location, on the western side of the bridgeway at West Orange Ave (Figure 3). The Lower Colma Creek Gauge is located east of South Airport Blvd where Colma Creek enters San Francisco Bay and was not used for this project.

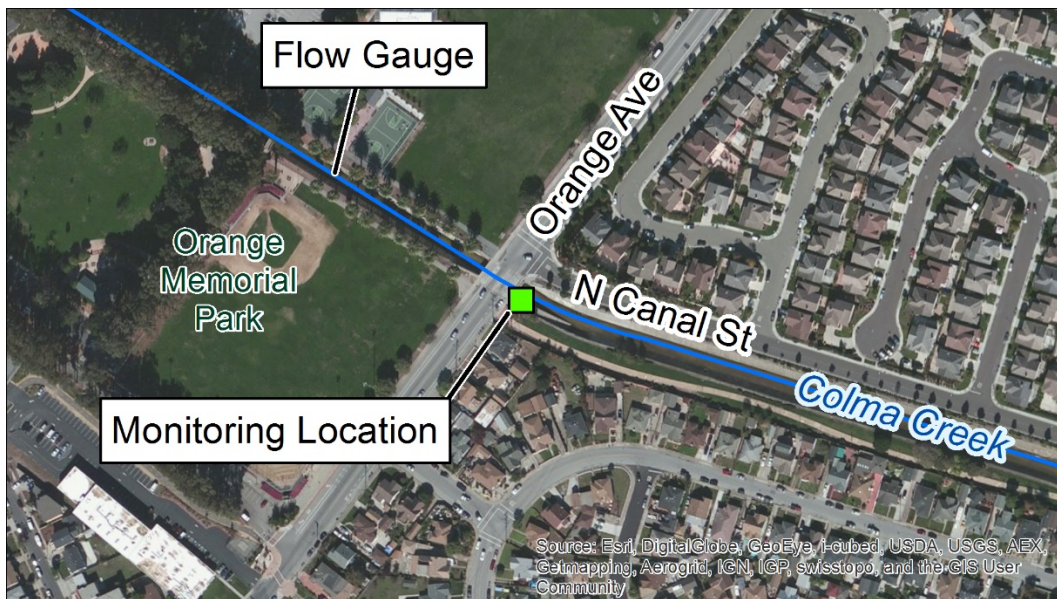

Figure 3. TCT monitoring location and flow gauge location at Colma Creek (South San Francisco)

<sup>4</sup> <http://www.sfn.usace.army.mil/Portals/68/docs/regulatory/publicnotices/2016/2016-00024plans.pdf>

## 2.2.2 Coyote Creek

Coyote Creek is a large creek with a mostly natural and wide riparian area that drains into the lower end of South San Francisco Bay. The Coyote Creek watershed is 322 square miles, with 61% of the watershed above Anderson Dam and Reservoir, which serves water supply, flood control, and recreational purposes. The Coyote Creek watershed drains around half of the City of San Jose, with a population of nearly one million people.<sup>5</sup> Coyote Creek is highly impacted from trash, originating from a mix of urban runoff and the large transient population that lives along its banks. The monitoring site is downstream of most of the sources of trash to the creek, and a high volume of trash is expected to be pass by this location during storm events. Coyote Creek was a priority monitoring site because it is one of the few accessible urban rivers assessed by the project.

Coyote Creek is listed as critical habitat for federally listed steelhead. NOAA and the California Department of Fish and Wildlife approved the project with the stipulation that the project would terminate if any steelhead were seen in the vicinity. No species were seen during our sampling event in May 2016.

The monitoring site was located on the north side of Charcot Avenue (Figure 4). USGS Gauge 11172175 is located on Coyote Creek below Highway 237, approximately 3.5 miles north of the sample location although there are only five outfalls draining 1.3 square miles between the gauge and the monitoring station, so the flow is expected to be similar. The USGS gauge records discharge and gauge height every 15 minutes and dates to at least 2003.

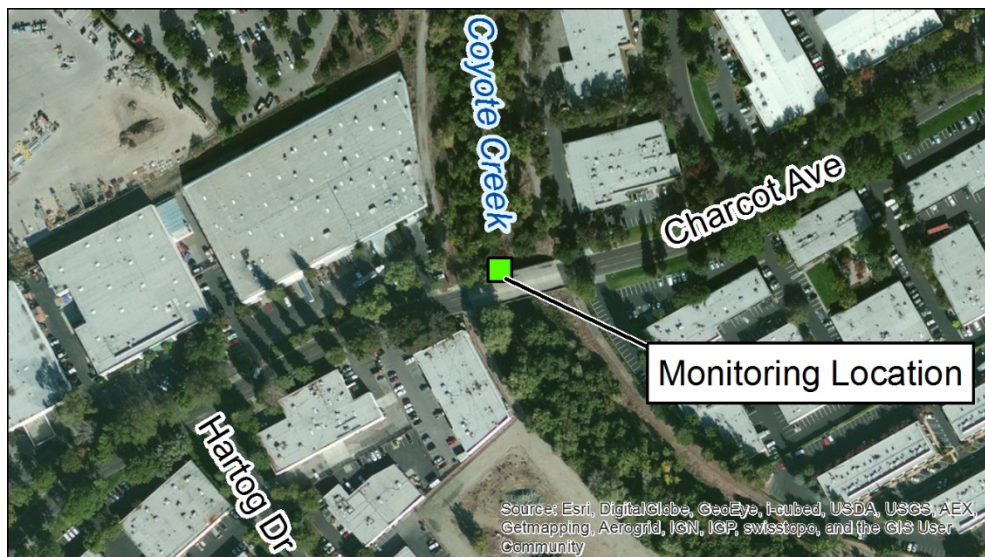

**Figure 4. TCT monitoring location at Coyote Creek (San Jose)**

<sup>5</sup>

[http://www.valleywater.org/uploadedImages/Services/HealthyCreeksEcoSystems/WatershedInformation/Coyote/Coyote2005MapXL\(1\).jpg?n=764](http://www.valleywater.org/uploadedImages/Services/HealthyCreeksEcoSystems/WatershedInformation/Coyote/Coyote2005MapXL(1).jpg?n=764)



### 2.2.3 San Mateo Creek

San Mateo Creek is a small creek with a natural channel with a narrow riparian area that flows from Sweeney Ridge through urban areas to the San Francisco Bay. The watershed for San Mateo Creek includes 33.5 square miles, although all but 4.6 square miles of the watershed is upstream of Crystal Springs Dam and Reservoir. The concrete gravity dam was constructed in 1888 by the City of San Francisco for water supply purposes.

Monitoring locations on the western side of Highway 101 and at Gateway Park near the intersection of South Humboldt Street and East 3<sup>rd</sup> Avenue were discarded due to high traffic. The selected monitoring location was the pedestrian/bicycle bridgeway in Gateway Park (Figure 5). This location was ideal because there was no vehicular traffic, making permitting and traffic control easier than the three other monitoring sites.

USGS Gauge 11162753 is in San Mateo Creek below Interstate 280, approximately 4.1 miles upstream of the sample site. The gauge is located just downstream of the Crystal Springs Dam, which releases flows consistently year-round. The dam was releasing water around 20 cubic feet per second (cfs) during both monitoring events on San Mateo Creek, much higher than the normal release of around one cfs.



Figure 5. Monitoring location at San Mateo Creek (San Mateo)

## 2.2.4 Arroyo Seco

The Arroyo Seco is a concrete channel with a watershed of approximately 47 square miles and includes the San Gabriel Mountains and several communities, including Pasadena and a part of downtown Los Angeles.<sup>6</sup> The Arroyo Seco watershed is a sub-watershed of the Los Angeles Watershed.

The Arroyo Seco monitoring site, within the Rose Bowl parking lot in Pasadena, has a watershed of 35.9 square miles and was selected because of accessibility and channel dynamics. The Rose Bowl section of the Arroyo Seco has a narrow inner channel that flows year-round. Traffic control within the parking lot was manageable because of limited traffic within the region. Many of the other Los Angeles area sites evaluated were rejected because either the bridgeway was too high (>30 feet), on a busy street, or the anticipated flows were above estimated equipment capabilities.

USGS Gauge 11098000 is located on the Arroyo Seco in Fern Canyon (Figure 2 and 6), located approximately 5 miles northeast of the monitoring site. The Devil's Gate Dam and Reservoir, built for flood control purposes in 1920, is two miles above the monitoring site, and regulates flow above that location. Flow was irregular during sampling collection, likely because of the dam releasing varying amounts of water. Despite the irregular flow, the site allowed testing to occur during high flows.



Figure 6. Monitoring location at Arroyo Seco (Pasadena)

<sup>6</sup> [https://dpw.lacounty.gov/wmd/npdes/2003-04\\_report/Section2.pdf](https://dpw.lacounty.gov/wmd/npdes/2003-04_report/Section2.pdf)

## 2.3 Monitoring Methods

The TCT Project SAP (Geosyntec et al. 2014) included Standard Operating Procedures (SOPs) for the monitoring receiving waters. The SOPs were based on existing methods used to monitor trash and plastic pollution in aquatic environments. The Project planned to have at least one dry weather event and one storm event at each of the four monitoring sites, although Coyote Creek was only sampled a single time. During dry weather sampling events the field staff was on site for less than eight hours. During storm sampling, field staff attempted to collect samples throughout the period of stormwater runoff, arriving on site approximately when rainfall began, and remained at least some time into the decreasing hydrograph, although storm timing and logistics often made this not possible.

The monitoring equipment setup was roughly the same at each monitoring site. The setup included a USGS Type-A Boom Truck and Crane Four-Wheel Truck Model 4350<sup>7</sup> (USGS Crane) (with lead weights) on a bridgeway with multiple types of trawls being deployed into the receiving water below (Figure 7 and Figure 8). The USGS Crane for the TCT Project was borrowed from San Francisco Estuary Institute (SFEI), and is typically used to carry out suspended sediment sampling in flowing water bodies.

To position the USGS Crane in the correct position, the waterbody was observed visually and field staff situated it above the center of the waterbody or above the fastest moving surface waters. Once the USGS Crane was positioned in the correct location on the bridgeway, the system was weighed down by two 25-pound lead weights on the back of each side. If the channel was split by at least one bridge pier, like at Colma Creek, the fastest moving section of the receiving water was monitored.



Figure 7. Photo of USGS Crane at Arroyo Seco in Pasadena, CA

<sup>7</sup> Available at Rickly Hydrological Company



**Figure 8. Photo of field team next to USGS Crane at San Mateo Creek**

At each site, depending on velocity of the water, multiple trawls were attached to the USGS Crane's steel cable. The cable was approximately 150 feet long; however, no more than 30-35 feet of cable was used. Each trawl was attached by a bridle (system made of sturdy line attached to the top of each trawl) and one or two lines were also attached to trawl to help guide it in and out of the receiving water. Figure 9 shows the manta trawl attached to the USGS Crane at San Mateo Creek.

A flow meter was attached to each trawl to measure the velocity of the water during higher flows. Figure 10 shows the flow meter attached to the Rectangular Trawl. The flow meter was difficult to use, however, because it did not perform correctly in low flows and during high flows, trash and debris accumulated around the meter causing its wheel to malfunction.



Figure 9. Manta Trawl bring deployed at San Mateo Creek



Figure 10. Rectangular Trawl with flow meter attached at San Mateo Creek

Trawls were deployed mechanically by the USGS Crane, but could have been deployed by hand in low flow with the appropriate permits. Each trawl was deployed to collect a sample representative of an established time period, ranging from a few minutes to an hour, depending on the flow of the receiving water and how rapidly the trawl was filling with trash and debris. Table 2 describes the length of time required to collect a sample during different flow periods. Generally, trawls were deployed for 60 minutes when little to no trash was present in the water column, such as during the dry events. During storm events and higher flows, trawls were deployed between 3 and 15 minutes due to the capacity of the trawl filling up quickly with debris and trash, requiring them to be retrieved after shorter time periods.

**Table 2.** Estimated times that each trawl should be deployed

<b>Flow Range (cubic feet/second)</b>	<b>Time Deployed (mins)</b>
<8	30 - 60
>8	3 - 15

Four trawls, including a Manta Trawl, High Speed Trawl, Mini High Speed Trawl, and Rectangular Trawl were fabricated for the project. Each included a 5mm custom net that was fabricated and attached to the outflow of each. A streambed sampler was also purchased for the project, but never used because of deployment difficulties and permit limitations. The Rectangular Trawl was designed and built for the project, and then modified during the project, resulting in a new trawl called the Weighted Rectangular Trawl (also called the Blue Boxy Trawl). Each trawl used during the Project is described below.

### 2.3.1 Manta Trawl

The Manta Trawl is a modified Neuston net with a rectangular opening of 16 cm high by 61 cm wide, aluminum frame, and a 3m long 5mm net with 30 x 10 square cm collecting bag. This trawl was designed to skim a water body's surface waters and works best at speeds of less than 3 knots. The Manta Trawl has been used extensively over the last 20 years to collect microplastic samples in oceans and lakes. The Manta Trawl was used at each of the receiving sites except for Coyote Creek where the project was limited by the project's Traffic Control Plan that was issued for the TCT Project.

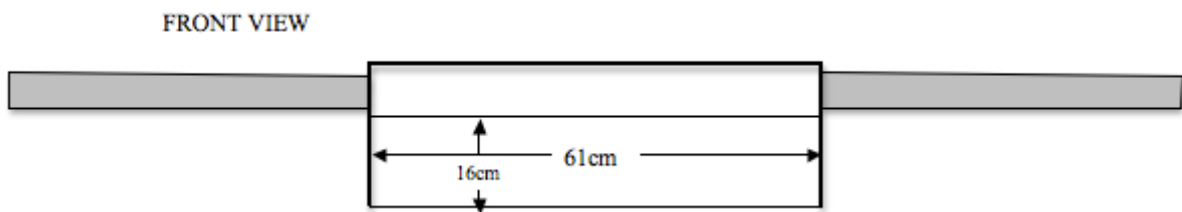

Figure 11. Manta Trawl photograph and sketch with dimensions

### 2.3.2 High Speed Trawl

The High Speed Trawl is a modified Neuston net with a rectangular opening of 40 cm high by 15 cm wide, aluminum frame, and a 3m long 5mm net with 30 x 10 square cm collecting bag. The High Speed Trawl was designed by 5 Gyres Research Director Marcus Eriksen in 2011 to be used during research Expeditions to document plastic pollution in our oceans. This trawl was designed to skim the water's surface at speeds up to 8 knots and used to collect samples from sailing vessels moving at higher speeds than those generally required for sample collection with the Manta Trawl.

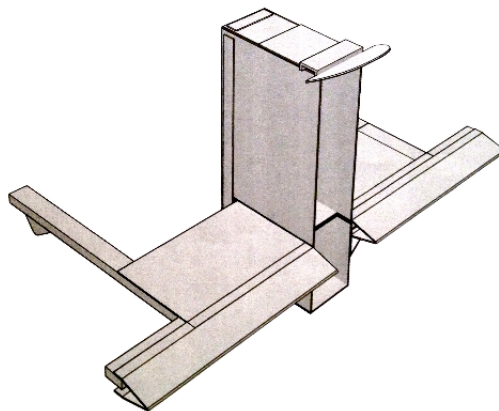

Figure 12. High Speed Trawl photograph and sketch



### 2.3.3 Mini High Speed Trawl

The Mini High Speed Trawl is a modified Neuston net with a 60 cm high and 15 cm wide rectangular opening, aluminum frame, and a 3m long 5mm net with 30 x 10 square cm collecting bag. The Mini High Speed Trawl was designed by 5 Gyres Research Director Marcus Eriksen in 2013 to accommodate requests from around the world to borrow trawls.<sup>8</sup> This trawl was designed to skim the water's surface at speeds above 8 knots, and can be folded to fit in a suitcase.

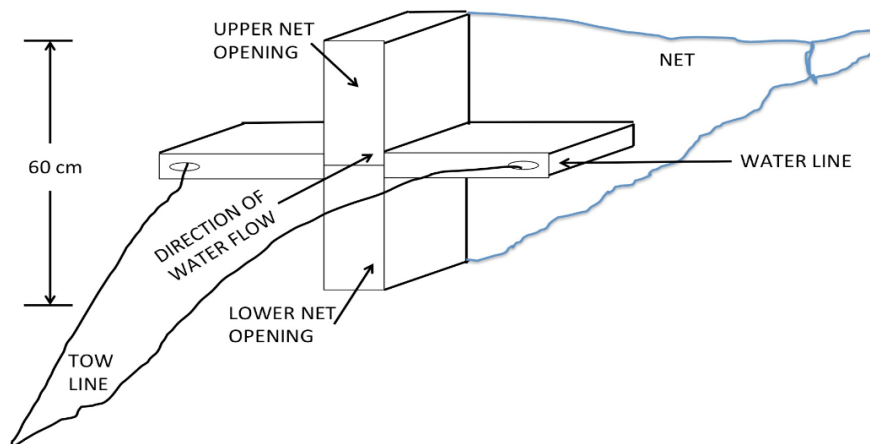

Figure 13. Mini High Speed Trawl photo and sketch with dimensions

<sup>8</sup> <http://www.5gyres.org/science-programs/>

### 2.3.4 Rectangular Trawl and Weighted Rectangular Trawl

The Rectangular Trawl and Weighted Rectangular Trawl are modified Neuston nets with a 46 cm high and 46 cm wide square opening. The dimensions and design of the trawl was based on discussions with several experts, including Dr. Sherri Mason and USGS scientist Austin Baldwin. 5 Gyres staff decided to fabricate a rectangular steel trawl (rather than use PVC piping) to make a more robust, heavier and durable trawl. The rectangular trawl was designed to be used to collect samples from the surface and mid-water column, and possibly even the bottom of the water column.

The Rectangular Trawl was further modified after several sampling events to include additional weight at the bottom of the trawl with a heavy-duty stand to stabilize the trawl. This modified trawl was named the Weighted Rectangular Trawl (Blue Boxy). The Weighted Rectangular Trawl also has a 46 cm high and 46 cm wide square opening but includes two 15-pound flat steel plates, with the capability of additional weights being added (Figure 14).

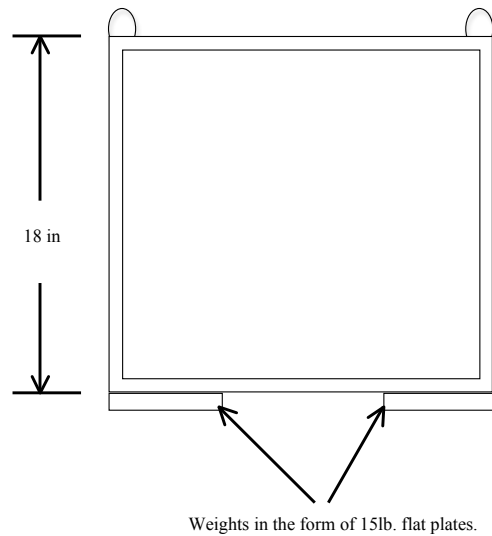

**Figure 14. Photograph of 5 Gyres Research Director Marcus Eriksen holding the Rectangular Trawl (silver) and Weighted Rectangular Trawl (Blue) and sketch with dimensions.**

### 2.3.5 Other Equipment Analyzed

A streambed sampler (Figure 15) was originally proposed to collect samples along the bottom of each water body. The sampler that was purchased for the project has a 0.15m x 0.15m net captures all trash and debris greater than 5 mm. The sampler weighed close to 150 lbs and was very large, making the feasibility of deployment with the given equipment not possible. The streambed sampler requires the use of a tow truck or larger crane than the one used to lower the trawl into the waterbodies. Because the use of additional equipment to the USGS Crane was found to be very difficult to permit, the streambed sampler was not used in the field.

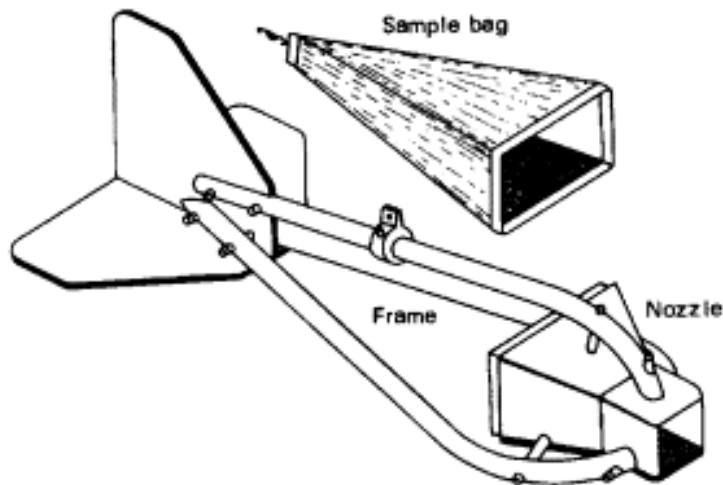

Figure 15. Streambed Sampler photograph and sketch

A mechanical pump was also suggested early on by project partners and the TAC. The proposed method included a 2 to 4-inch diameter intake hose connected to a pump that would allow material (water, trash, natural debris, etc) to pass through the pump and through a 5 mm screen. The method was evaluated and was found to be infeasible and not practicable based on the weight of the equipment (hosing and pump), diameter of pump hose, and the logistics needed to place the equipment at the site. The other trawls require a bridge for deployment and the "Trash Pump" would not work well from a bridge and therefore was not included in this project. The use of the pump system to monitor trash is limited because intake hoses often are not large enough to accommodate collecting samples of the size of material that is observed in waterways. However, the use of a pump to monitor microplastics is becoming more common.

The original project proposal called for the use of a tow truck to lower and raise the trawls from the bridgeway in high flows. Several of the cities prohibited the use of such vehicles, because they felt that the truck was a safety hazard and would interfere with traffic control measures. In response, the project was modified to include only the USGS Crane. This saved costs related to renting a tow truck and hiring more personnel to operate the truck, which would have cost thousands of additional dollars.

## 2.5 Quality Assurance and Control Procedures

All quality assurance controls developed and implemented during the TCT project are described in the project's Quality Assurance Project Plan (QAPP) submitted to the State Water Board (Applied Marine Sciences 2014). The stringent procedures described in the QAPP were essential for obtaining unbiased, precise, and representative measurements and for maintaining the integrity of the trash samples during collection, handling, and analysis, as well as for measuring elements of variability that cannot be controlled. Stringent procedures were also applied to data management to assure that accuracy of the data is maintained.

Data Quality Objectives (DQOs) were established to ensure that data collected are sufficient and of adequate quality for the intended use. DQOs include both quantitative and qualitative assessment of the acceptability of data. The qualitative goals include representativeness and comparability, and the quantitative goals include completeness, precision, and accuracy. Specific DQOs were based upon Measurement Quality Objectives (MQOs) identified for the TCT project and included in the project QAPP.

Approaches used for data quality assurance for assessments and characterizations of trash do not have the same application as more commonly-used chemical analyses. Instead of using the repeatable physical and chemical properties of target constituents to assess accuracy and precision, information and data collected on trash are quantified using personnel trained in the characterization and classification of data. Compounding the challenge between chemistry and quantification of trash is the inherent spatial and temporal variability in trash loading and transport. Unlike chemical data where replicate sampling and analysis of samples are expected to be similar, no such expectation exists for trash data. Hence, DQOs in the QAPP have a strong emphasis on training and oversight, with intercomparisons between performance of individual field team members participating in the various assessment and characterization efforts. In addition, chemical approaches that focus on accuracy do not apply to trash monitoring. For example, matrix spikes used for chemistry have no parallel for trash samples. Thus, a new approach using intercalibration amongst personnel conducting assessments/characterizations was the primary mechanism for assuring accuracy and precision.

### 3. SAMPLING REQUIREMENTS

#### 3.1 Permitting

The permitting process for the TCT project was rife with difficulties and greatly delayed monitoring. Permit delays prevented the team from monitoring several of the early storms that brought heavy rain to the monitoring sites during the 2015-2016 El Niño year. Monitoring all four locations required seven permits. It took the cities, counties and districts two to six months each to approve the project, process applications, and provide the permits necessary for the field work to begin.

For the Arroyo Seco monitoring site, permits were required from the County of Los Angeles Department of Public Works and the City of Pasadena. The permit from the City of Pasadena was reviewed by a board before approval, taking four months to be issued. The City of Pasadena's permit also came with restrictions, such as prohibiting the monitoring of storms that occurred during city events, limiting sampling equipment, and prohibiting the use of a tow truck. After conducting the first round of testing in the Arroyo Seco, the project team discovered that the approved testing location was not a good spot for monitoring high-flow events. The project team requested to move the testing location to a pedestrian bridge less than 1,000 feet north. The request was denied and both permits for the Arroyo Seco location were amended after a fee. The location change took three months to finalize and sampling was never done at the new location because of limited storms and the project's timeline.

For the project to monitor at Coyote Creek, permits from the Santa Clara Valley Water District and the City of San Jose were needed. Obtaining the permit from the Santa Clara Valley Water District required additional planning and communication with California Department of Fish and Wildlife because Coyote Creek is listed as a critical habitat for federally protected steelhead. The team received approval from the Department of Fish and Wildlife after measures designed to minimize impact to aquatic life, were presented.

After receiving the permit from the Santa Clara Valley Water District, the permit from the City of San Jose took six months to apply for and obtain. The City of San Jose required precise auto insurance documentation that the project's carrier could not provide even though the appropriate coverage was in place. The project team chose to keep their vehicles parked on Santa Clara Valley Water District property during testing, since they were not able to provide the required documentation to the City of San Jose.

Figure 16 is a flowchart created to describe the TCT Project permitting process that was used at each site to understand if a permit was required. More than 15 entities were consulted during this program and weighed in on project details and gave some authority over the project. In addition, multiple local non-profits and companies were also involved. Table 3 describes which agencies were involved and the approximate time spent to receive each permit. Appendix A includes copies of all permits obtained for the TCT project.

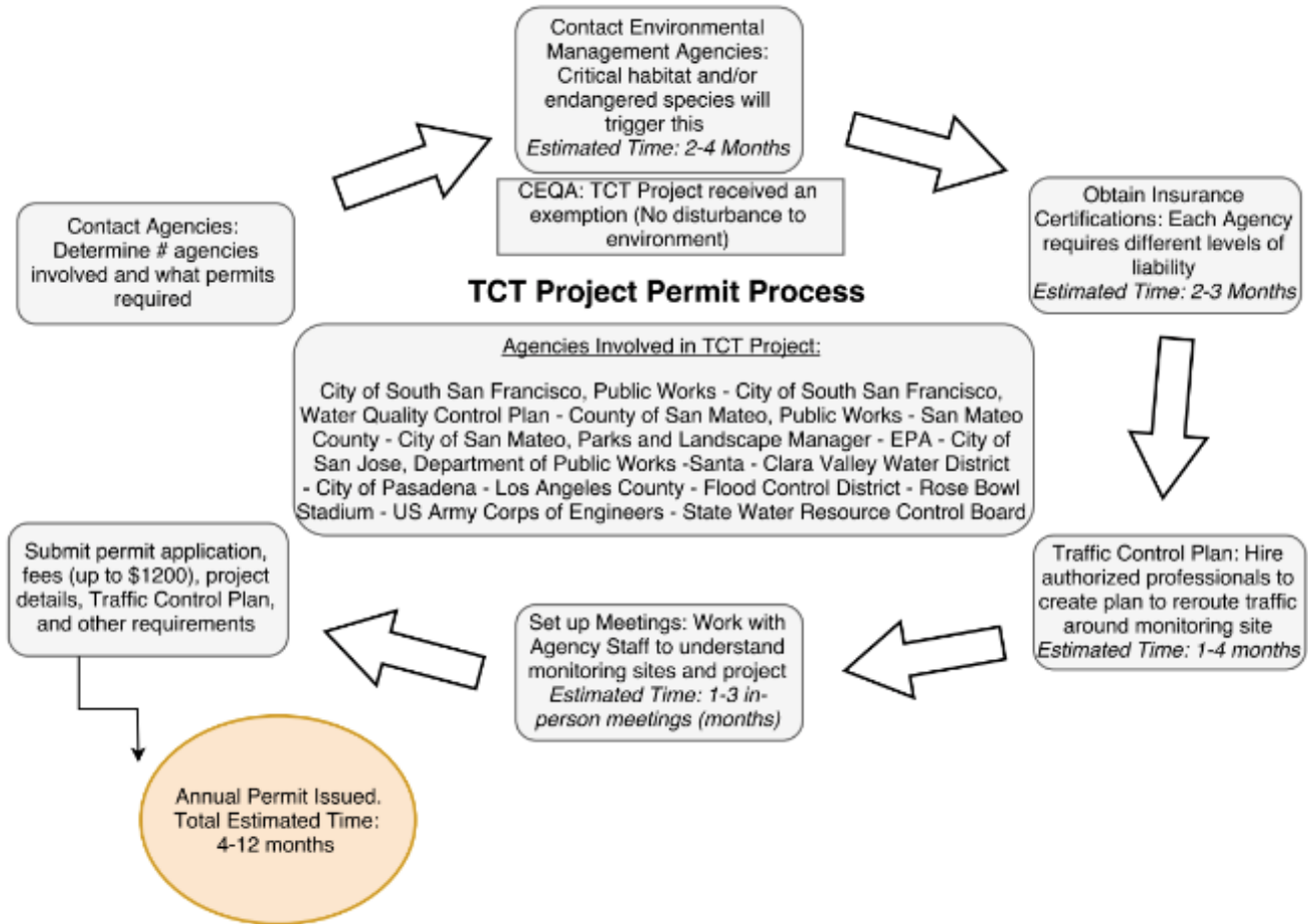

**Figure 16. Flowchart of the permitting process for the TCT Project**

The project was determined to be exempt from CEQA. The exemption (15306 Class 6) was issued because the project consists of basic data collection, research, experimental management, and resource evaluation activities that do not result in a serious or major disturbance to an environmental resource.

Insurance, often specific to each site, was required for many aspects of the project to obtain the appropriate and required permits. Additionally, Traffic Control Plans were required for each site and were referenced and included in any authorization from involved entities issuing permits.

**Table 3.** Details related to permits required for each monitoring site

Monitoring Site	Permitting Agency	Permit	Requirements to Obtain Permit	Approx. Time to Obtain Permit	Permit Limitations
Colma Creek	County of San Mateo	Encroachment	Project Scope Document, Traffic Control Plan, Insurance	4 months	Valid for 14 months
	City of South San Francisco	Encroachment	Project Scope Document, Traffic Control Plan, Insurance	4 months	Valid for 14 months
San Mateo Creek	City of San Mateo – Department of Public Works	Encroachment	Project Scope Document, Traffic Control Plan, Insurance	2 months	Valid for 3 months, must be delivered in person, can extend over the phone
Arroyo Seco	County of Los Angeles Department of Public Works Flood Control District	Flood Access Short Term	Project Scope Document, Insurance	4 months	Valid for 4 months
	City of Pasadena Department of Public Works	Public Works	County of Los Angeles Department of Public Works Flood Control District Permit, Project Scope Document and Traffic Control Plan, Insurance	3 months	Valid for 6 months, must provide a 72 hour advance notice to City prior to the commencement of activity. Will not be able to monitor on the same day/time as Rose Bowl and/or other City events. Expensive permit fees.
Coyote Creek	Santa Clara Valley Water District	Encroachment/ Temporary	Project Scope Document, Traffic Control Plan, Insurance	6 months	Valid for 3 months
	City of San Jose Department of Public Works	Revocable Encroachment	Santa Clara Valley Water District Permit, Project Scope Document, Traffic Control Plan, Insurance	6 months	Valid for 3 months, Expensive Permit Fees

### 3.2 Mobilization

For each sampling event, 3-4 field crew were present, with at least two having prior experience with each of the trawls. The main components of the research equipment brought to each monitoring event include:

- USGS Boom Truck and Crane,
- Weights for the Crane,
- Manta Trawl with 5mm mesh,
- Hi Speed Trawl with 5mm mesh,
- Mini Hi Speed Trawl with 5mm mesh,
- Rectangular Trawl with 5mm mesh,
- Weighted Rectangular Trawl with 5mm mesh,
- Line to attach equipment,
- Black durable garbage bags,
- Sample bottles,
- 5-gallon buckets,
- Large tarp,
- Flowmeters,
- Pole for flowmeter,
- Shackles,
- Steel-toed boots,
- Gloves,
- Waders,
- Orange vests,

- Clipboard,
- Pens,
- Markers,
- 5 mm sieves,
- Rulers,
- Tweezers, and
- Locking carabineer.

Figure 17 shows the equipment packed in the back of a pickup truck. In addition, traffic-control equipment was also brought to the sampling locations. This equipment varied by site, but included:

- High level warning devices,
- Traffic barricades,
- Traffic cones/delineator,
- Delineation-mounted signs,
- Traffic control signs (weighing 20+ pounds each),
- Delineation centerlines,
- Flags,
- Work area signs,
- Closure signs,
- Flashing arrow boards,
- Road work ahead, and
- Detour signs.



Figure 17. Transportation of trawls and field equipment by truck to Arroyo Seco from San Francisco





Figure 18. Traffic control measures at Colma Creek (cones and signage)

### 3.3 Storm and Creek Monitoring

The project planned to monitor four receiving waters, representing different receiving water types, during different flow periods, focusing on at least one dry event and one wet event (Table 4).

Table 4. Proposed Receiving Water Monitoring Sites and water body type

Region	Receiving Water	Water Body Type
San Francisco Bay Area	Colma Creek	Small Channelized Creek
	Coyote Creek	Large Riparian Creek
	San Mateo Creek	Small Riparian Creek
Los Angeles Area	Arroyo Seco	Large Channelized Creek

When possible, during wet weather events, samples were collected throughout the entire storm event, with emphasis on sampling during the rising hydrograph. The purpose of sampling throughout an entire storm event is to understand the timing of how trash moves through the watershed and receiving water during a storm. Understanding how trash fluctuates during an individual storm will help prioritize when sampling should occur. Factors that may affect trash levels and timing within a receiving water include the size of the watershed, the trash generation rates of upstream areas and the size of those areas, the

distance those areas are from the monitoring site, the slope of the channel, the type of channel (natural versus channelized, which will affect water velocity), the area upstream that is treated with trash capture systems, the time of antecedent dry period, and the size of the storm being monitored. Also, illegal dumping and transient population along the waterway may also contribute significant quantities of trash to the channel. Data collected will be used to understand which time periods in a storm may be most important for trash mobilization. It was anticipated that the highest amount of trash is mobilized near the beginning of the storm, and therefore the trash rates are highest during the rising hydrograph and increasing storm intensity.

If stream gauge data is available at the monitoring sites being considered, the flow data should be plotted along with precipitation to better understand the shape of the hydrograph from previous storms. This will assist field staff in understanding generally how long the time period is of the rising hydrograph. This will allow field staff to better time the samples if there are a certain number of samples that are desired along different portions of the hydrograph. For example, a relatively small watershed with a concrete channel and high slope, such as Colma Creek, is going to have a very short rising hydrograph and samples will need to be collected very frequently. A larger more natural system with a much lower slope, such as Coyote Creek, will have a much longer rising hydrograph. In the case of Coyote Creek, the trash in stormwater originating from the south end of San Jose may take several hours to reach the monitoring station, and the samples would have to be timed appropriately.

### **3.4 Sample Characterization**

Trash collected from the receiving waters analyzed during this project were characterized using procedures included in the Sampling Analysis Plan (Geosyntec et al. 2014). The procedure consists of measuring the weight and volume of debris and trash, along with the counts of four types of trash (plastic bottles, glass bottles, plastic bags, and expanded polystyrene (EPS)). Trash is characterized into 13 sub-categories. This characterization allowed our trash rates to be accurately measured for both volume and weight for each sample. Table 5 shows a portion of the characterization data (only significant volumes) for the storm that occurred at Colma Creek on November 24, 2015. Trash categories that did not include any items over 5mm in the Colma Creek sampling event are not included in Table 5. These additional trash categories include: Glass CRV, Plastic Bags, Plastic Food-ware, Glass Other, and Metal. A table of the characterization data for each sample is available in Appendix B, along with data sheets describing the trash type and quantities.

**Table 5.** Characterization data in volume for the monitored storm on Colma Creek November 24, 2015

BASMAA Sample ID	Trawl Type	Plastic CRV (#)	EPS (#)	Debris Vol (gal)	Plastic CRV Vol (gal)	EPS Vol (gal)	Mylar Vol (gal)	Plastic Other Vol (gal)	Paper Food-ware Vol (gal)	Bulk Paper Vol (gal)	Cigs Vol (gal)	Misc Vol (gal)	Total (gal)
Colma-RT-01	Rectangular			0.00	0.00	0.00	0.00	0.00	0.00	0.00	0.00	0.00	0.00
Colma-MT-01	Manta			7.95	0.00	0.00	0.16	0.26	0.00	0.08	0.00	0.01	0.51
Colma-M-HS-01	Mini High Speed	1		6.79	0.06	0.00	0.01	0.11	0.00	0.02	0.00	0.01	0.21
Colma-HS-01	High Speed			3.57	0.00	0.00	0.11	0.67	0.03	0.03	0.01	0.05	0.88
Colma-MT-02	Manta			5.45	0.00	0.00	0.02	0.83	0.25	0.01	0.01	0.01	1.14
Colma-M-HS-02	Mini High Speed	1		2.59	0.13	0.00	0.00	0.31	0.12	0.01	0.01	0.00	0.57
Colma-HS-02	High Speed			0.50	0.00	0.00	0.00	0.12	0.00	0.00	0.01	0.02	0.15
Colma-MT-03	Manta			1.33	0.00	0.00	0.01	0.03	0.00	0.02	0.01	0.03	0.10
Colma-RT-02	Rectangular			0.89	0.00	0.00	0.00	0.01	0.00	0.00	0.00	0.00	0.02
Colma-RT-03	Rectangular		1	0.89	0.00	0.001	0.01	0.00	0.00	0.00	0.00	0.00	0.01
Colma-RT-04	Rectangular		1	0.28	0.00	0.001	0.00	0.00	0.00	0.00	0.00	0.00	0.00
Total		2	2	30.23	0.19	0.003	0.31	2.35	0.40	0.16	0.05	0.13	3.59

### 3.5 Weather Forecasting and Rainfall

The TCT project used many websites to monitor weather and predict rainfall quantity for fieldwork preparation and data analysis. The National Oceanic & Atmospheric Administration (NOAA) Hourly Weather Graphs provided predictions up to 12 hours in advance. The NOAA National Centers for Environmental Information database also provided 24-hour precipitation measurements and seasonal storm frequency prediction based on historic data collection. This database was used for all eight sampling events. The Accuweather forecast tables displayed weekly weather predictions utilized for field work planning. Weather.com provided present time radar viewing and short-term (less than 48 hours) hourly weather prediction. Weather Underground provided hourly rain data used for each monitoring event. Table 6 describes available data from websites used to track weather during the project.

**Table 6.** Websites to monitor weather forecasts

Organization	Website	Data Available	Data Use
The National Oceanic & Atmospheric Administration (NOAA)	<a href="http://forecast.weather.gov/MapClick.php?lat=37.6547&amp;lon=-122.4077#.WGc8s1wjQs">http://forecast.weather.gov/MapClick.php?lat=37.6547&amp;lon=-122.4077#.WGc8s1wjQs</a>	Hourly Weather Graphs	Predictions up to 12 hours in advance
	<a href="https://www.ncdc.noaa.gov/data-access">https://www.ncdc.noaa.gov/data-access</a>	Historic Database 24-hour	Precipitation measurements and seasonal storm frequency predictions
Weather.com	<a href="https://weather.com/weather/today/l/USCA1085:1:US">https://weather.com/weather/today/l/USCA1085:1:US</a>	Radar viewing and short-term prediction	Present time viewing and hourly weather prediction (less than 48 hours)
Accuweather	<a href="http://www.accuweather.com/en/us/south-san-francisco-ca/94080/weather-forecast/337259">http://www.accuweather.com/en/us/south-san-francisco-ca/94080/weather-forecast/337259</a>	Forecast tables	Weekly weather predictions utilized for field work planning
Weather Underground	<a href="https://www.wunderground.com/cgi-bin/findweather/getForecast?query=South+San+Francisco%2C+CA">https://www.wunderground.com/cgi-bin/findweather/getForecast?query=South+San+Francisco%2C+CA</a>	Hourly rain data	Monitoring each event and for data analysis

### 3.6 Recording Flow

If trash rates are to be calculated for the entire waterbody during an event, it is essential to understand the water velocity through each trawl's net during each sample so that the flow rate passing through the trawl can be calculated. To capture velocity, the Project's SAP planned for flow data at each site to be determined using two methods: (1) A flowmeter was attached to each trawl to record local flow at the time of sample; (2) Nearby flow gauges, managed by the USGS and City of South San Francisco, captured data every 15 minutes. It also important to measure or estimate the depth of water relative to the trawl to calculate cross-sectional area of water entering the trawl. The flow rate in meters cubed per second entering the trawl during a sample is:

$$Q_T = vA \left( \frac{d}{h} \right)$$

Where:

$Q_T$  = Total flow through the trawl ( $\text{m}^3 \text{s}^{-1}$ )

$v$  = Velocity of the water through the trawl ( $\text{m s}^{-1}$ )

$A$  = Cross sectional area of the opening of the trawl ( $\text{m}^2$ )

$h$  = Height of the opening of the trawl (m)

$d$  = Depth of the water relative to the bottom of the opening of the trawl (m)

Measuring the velocity with the flowmeter was unsuccessful during some of the monitoring events. During our first monitoring event in Colma Creek, the water was too shallow for the flowmeter. Problems with the flowmeter continued throughout our testing. The wheel on the flowmeter did not always consistently spin. During higher flows at Colma Creek and other sites, the flowmeter also experienced problems from debris clogging the area around the flowmeter and not allowing for proper spinning of the flowmeter's wheel. The same thing occurred at other sites during low and high flow.

The flowmeter was so inconsistent and poor that the data was not used. A possible solution is to not attach the flow meter to the trawl but to measure the flow velocity next to the trawl while the trawl is collecting a sample. The pole or cable holding the flowmeter would have to be long enough to reach the water, and the operator could not allow the flowmeter to contact any material that is flowing down the channel that might interfere with an accurate measurement. An alternative to a flowmeter measurement might include something basic to determine water velocity, such as an "orange peel" velocity method<sup>9</sup>. It is also possible that the relationship between flow depth and water velocity can be established at a site independent of and between samples. Therefore, only the depth needs to be measured during the sample and the velocity can be calculated later.

Instead of using the flowmeter data, this report was dependent on the discharge data provided by the nearby flow gages, which also provided problems since the gauges at San Mateo Creek and Arroyo Seco did not accurately reflect the flow at the monitoring sites because of the distance and the influence of dams. The data from these two gauges were used anyways, because it was not feasible to calculate the flow more accurately at the monitoring site. Three of the monitoring locations used data from gauges maintained by the United States Geological Survey (USGS)<sup>10</sup>. The USGS data records gauge height (feet) and discharge (cubic feet per second or cfs) every 15 minutes. The location of the USGS gauge used for the Coyote Creek, San Mateo Creek, and Arroyo Seco monitoring sites can be seen in Figures 1 and 2. For the Colma Creek monitoring site the flow gauge was only around 300 feet upstream of our monitoring site (Figure 3), and data was obtained from the City of South San Francisco Water Quality Control Plant.

## **4. MONITORING RESULTS AND DISCUSSION**

Field teams were successfully mobilized and conducted monitoring during eight events. One dry weather and one wet weather monitoring event were conducted at the San Mateo Creek and Arroyo Seco site, one dry weather and two wet weather event were conducted at Colma Creek, and one wet weather event was monitored at Coyote Creek.

### **4.1 Quality Assurance**

Stringent Quality Assurance (QA) and Quality Control (QC) procedures were developed for this project in order to obtain unbiased, precise and representative measurements, to maintain the integrity of the collected samples, and to ensure accurate data analyses. The Quality Assurance Project Plan (QAPP) and SAP for the project were referenced and followed during each step of the Project. Field personnel adhered to the field-sampling protocols to ensure the proper collection of representative samples and assessment of representative areas.

---

<sup>9</sup> An "orange peel" velocity test determines the velocity within a receiving water by timing how long it takes a brightly colored object, like an orange peel to move a specific distance downstream.

<sup>10</sup> Data available at <http://waterdata.usgs.gov/nwis>

Four distinct receiving water monitoring sites in the Los Angeles Area and the Bay Area were included in the project. Coordinates (five decimal places for latitude and longitude) recorded by field monitoring teams fell within 100m of target locations throughout the testing, assuring that the sampling occurred at the intended site. Monitoring occurred at a total of eight events as planned, demonstrating 100% completeness.

To ensure accuracy and precision, our field personnel were trained in the proper use of sample collection equipment and assessment methodologies before entering the field. The Project Manager emphasized training and oversight. We established Data Quality Objectives (DQOs) and taught these to field personnel to ensure that the data collected were sufficient and of adequate quality, and the staff team was compliant with reporting.

5 Gyres staff consistently monitored the weather to not only keep sampling personnel safe from extreme conditions, but also to maintain accurate sample representation. A wet weather event was classified as a precipitation event that produced greater than 0.25 inches of rainfall over a 24-hour period and a dry weather event as a time period of 48 hours or greater with less than 0.25 inches of rainfall.

While in the field collecting samples, the field team maintained QA/QC by utilizing the appropriate field data sheets, taking photos and videos of the samples, labeling sampling containers with the appropriate sample ID numbers and storing our field data sheets with the samples prior to characterization.

Trash and debris collected via sampling was characterized via methods developed outlined in the SAP and QAPP. Staff were trained on the assessment protocols prior to conducting the quantitative trash characterizations. Trash characterizations were performed for each sample obtained. Trained personnel identified moisture content, categorized individual trash samples, conducted item counts, took weights (measured using a scale within calibration, with a precision of 0.01 pounds) and measured volumes (with a precision down to 5 mL with the smallest container size).

Duplicate characterization measurements were conducted for individual trash samples. These duplicate analyses served as the primary indicator of precision for the project. Conducting duplicated characterization measurements prevented systemic errors, assuring waste items within a sample and/or item counts, weights, and volumes were identified and measured correctly. All duplicates for the project were performed by a trained staff member who did not perform the original measurements. All duplicate measurements were in normal range, ensuring 100% data accuracy.

A quality assurance evaluation of data collected during the project is included in Appendix C. All data was managed in a Project database also submitted to State Water Resources Control Board (SWRCB) as part of the Project.

## **4.2 Overview of Results**

The project successfully collected 57 samples during three dry events and five wet events, while successfully testing all of the equipment included in the Operations Plan. Table 7 summarizes field details for each monitoring site. Photographs of field events are provided in this section. Additional photographs are included in Appendix D.

Samples were collected with the Manta Trawl, High Speed Trawl, Mini High Speed Trawl, Rectangular Trawl and the modified Rectangular Trawl (weights added). The Manta and Weighted Rectangular Trawls were proven to be the most versatile since they could be used in high and low flow situations. The High Speed and Mini Hi Speed trawls proved to be acceptable though they are bulky and require a relatively deep and wide channel, which was not true for all of the sites monitored.

Each wet weather event aimed to monitor the beginning of a storm (rising of the hydrograph), with three of the five wet weather events successfully documenting the beginning of the storm by taking samples during the rising hydrograph (Colma Creek on Nov 24, 2015, San Mateo on Feb 17, 2016, and Coyote Creek on May 6, 2016). The small rain event monitored at Coyote Creek on May 6, 2016 is being considered a wet weather event because trash was mobilized during the beginning of the storm. The monitoring event at Colma Creek on April 7, 2015 is technically a wet weather event but sampling occurred several hours after rain stopped and very little trash was seen in the samples.

The field team had difficulty collecting samples throughout the entire storm in several cases because of equipment capabilities, logistics, and bandwidth of field staff. For example, rain on Feb 17, 2016 (at San Mateo Creek) did not begin until early evening even though the rainfall was predicted to fall much earlier in the day. The field team arrived in the late morning and sampled during the day before the storm and had put in nearly a full day of work by the time the creek started rising. Two of the eight samples were collected during the rising hydrograph in the first two hours of the storm. The last sample ended collection at 7:40pm. With the nighttime conditions and long working hours, the field crew decided to end sampling for that storm and not collect any additional samples during the rising hydrograph. Ideally, the field team would have monitored throughout the rising hydrograph and throughout the storm. The specific timing and quantities of rainfall that are forecast can be highly inaccurate and the field crew may need a great deal of flexibility when planning to monitor. It helps for the field crew to be relatively close to the monitoring site to reduce the occasions where they are waiting at a site many hours for the rain to begin.

**Table 7.** Monitoring locations, date, equipment used, and rainfall

Event	Receiving Water	Date	Samples Collected	Equipment Used	Rainfall (inches)	Wet/Dry Event	Days since last Rain
1	Colma Creek	3/4/15	4	Manta, Rectangular	Trace	Dry	24
2	Colma Creek	4/7/15	7	Manta, Rectangular	0.59*	Wet	2
3	Colma Creek	11/24/15	11	High Speed, Mini Hi Speed, Manta, Rectangular	0.25	Wet	9
4	San Mateo	1/29/16	6	Manta, Rectangular	Trace	Dry	6
5	San Mateo	2/17/16	8	Manta, Rectangular	0.45	Wet	15
6	Arroyo Seco	3/7/16	7	Rectangular	1.75**	Wet	n/a
7	Arroyo Seco	3/8/16	7	Manta, Weighted Rectangular	0.02	Dry	n/a
8	Coyote Creek	5/6/16	7	Weighted Rectangular	0.17***	Wet	9
		TOTAL	57				

\*Rain occurred several hours prior to sampling with little to no stormwater runoff during sampling

\*\*Most of the rainfall occurred prior to sampling. Hydrograph was falling when the sampling began.

\*\*\*Analyzed as a rain event

Figure 19 shows the breakdown of material (by volume) collected during the eight sampling events included in the project. This breakdown of the data shows that 9% (by volume) of all of the material that was collected was trash, with the remaining material being natural debris (mostly leaves and sticks). Of the trash that was collected, 58% of the material was plastic items, not including cigarettes that contain a filter that is plastic. Expanded polystyrene made up 5% of the total trash found, and plastic CRV bottles made up 8%. The "Plastic Other" category included plastic items such as plastic packaging, straws, and other items that did not fit in the other categories. Heavier items such as glass and metal were not collected in any other samples. There was also much less paper than the characterization data from the other sections of the TCT project. Additional characterization data is available in Appendix B.



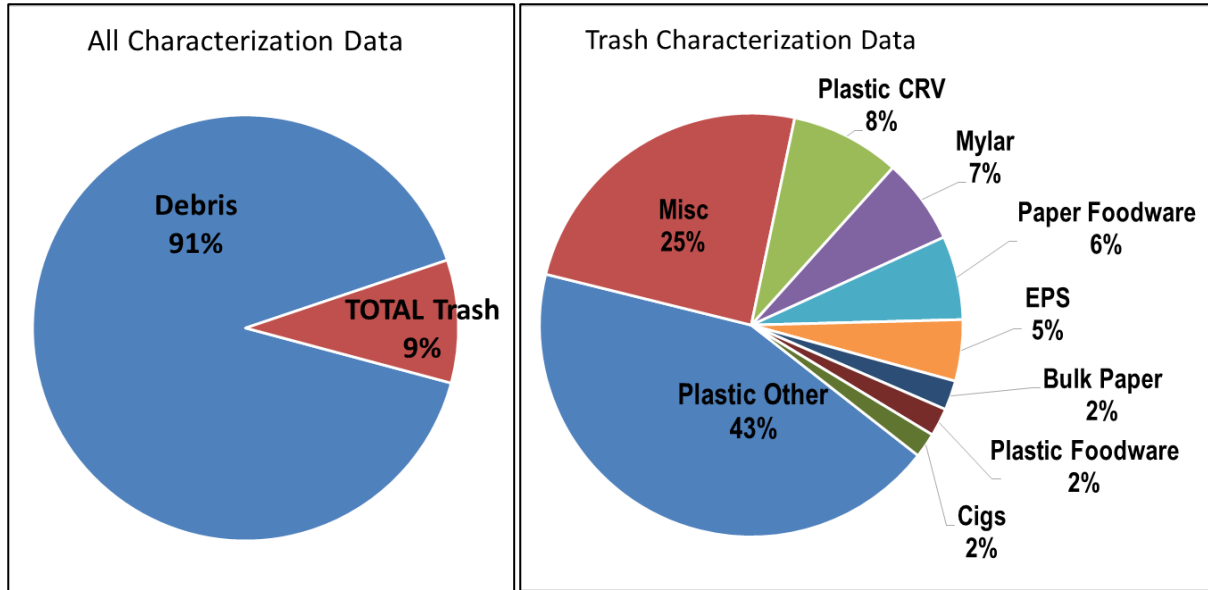

Figure 19. Pie chart for trash categorized by material for all samples collected (By Volume)

Pertinent information on monitoring trash trends was collected during this project. The project was able to determine estimated trash rates from the data collected during multiple small storm events. However, the information gained from planning the project and going through the logistics, permit processes, traffic control needs, site selection, and methods development, are some of the most important successes of the project. Additional research is recommended to fully understand the trash rates for the receiving waters included in this project.

### 4.3 Calculated Trash Rates

Fifty-seven samples were collected at the four selected monitoring sites using a variety of methods resulting in valuable data on trash rates related to discharge. Although the feasibility and evaluation of sampling methods was the main goal of this study, valuable trash loading data was also collected during each event.

By far, the highest trash rates were documented at Colma Creek on Nov 24, 2015, collected during a relatively small but intense 0.25-inch rain event. The trash visually increased in the creek as the flow increased, documenting that trash levels in creeks respond very rapidly as the creek's hydrograph begins to increase. The same effect was visually documented at San Mateo Creek and Coyote Creek during each rain event, though the calculated trash rates during those two events do not show as strong of a trend. For San Mateo Creek, this is most likely due to lower rates of trash in the watershed. For Coyote Creek, this is most likely because of the relatively small size of the storm and the thick vegetation along most of Coyote Creek that may prevent a lot of trash from moving far downstream during smaller storms like the one monitored. During the 0.17-inch storm event on Coyote Creek May 6, 2016 the trash rates were visibly increasing with the increasing hydrograph, but the sampling was terminated early because of unsafe traffic in the area.

The data collected confirmed that concentrations of trash were higher in the beginning of the storm, just as rainfall increased and with the rising hydrograph. This phenomenon represents trash that has

accumulated during dry periods on creek sides, in storm drains and on streets, that is then washed into the receiving waters during wet weather. The data shows that the first portion of the storm event (down to the first few minutes following the beginning of a storm), especially in receiving waters in concrete channels, can already have very high concentrations of trash. The response of trash rates to rainfall is expected to change depending on the initial intensity of the storm, where the monitoring site is relative to sources of trash in the watershed, and the channel characteristics that affect the velocity of water through the channel.

Samples collected during dry weather events (and “wet weather events” that occurred after rainfall) had little to no trash. For example, during monitoring on April 7, 2015, at Colma Creek, almost no trash was detected in the samples that were collected several hours after a 0.59 inch storm passed through the area. The monitoring event is defined as a wet weather event because sampling occurred less than 24 hours after more than 0.25” of rain; however, it was clear in the field and by the samples collected almost no trash was transported when monitoring occurred. Colma Creek is a very “flashy” system, with the rising and falling hydrograph occurring very rapidly (< 1 hour). The watershed is almost entirely urbanized with relatively high gradients above the monitoring location. The creek was already flowing at base flows when the sampling occurred.

The data shows that sampling during dry weather events and during the falling hydrograph does not produce nearly as useful data as capturing the rising hydrograph. Energy and time should be spent sampling sites at the beginning of rain events and during the rising hydrograph. This project intended to sample throughout the entire hydrograph, but logistical and permitting situations greatly limited this possibility. The definition of a wet weather event should be redefined to ensure that the rising hydrograph be included and that also smaller rain events should be included since the data shows these can also mobilize trash in receiving waters.

To estimate trash loading for the storms monitored on November 24, 2015 and February 17, 2016, the volume of water that passed through each trawl was calculated as previously demonstrated using the velocity of the water, the dimensions of each trawl and the estimated percentage of the trawl that was in the water. To calculate the trash rate in the creek, the flow of the entire creek was divided by the flow through the trawl, multiplied by the volume of trash collected in the sample, and divided by the time in minutes that the trawl was in the water collecting the sample. Since the project had difficulty measuring the velocity of the water at the trawl, it was assumed that the velocity of the water was the same for the cross-sectional area of the channel. This equation also assumes that the trash moving through the channel is well mixed and not more concentrated where the trawl is collecting the sample. This is not always a good assumption since the amount of trash may vary throughout the water column and across a channel.

$$R_T = \frac{QV}{Q_T t}$$

Where:

$R_T$  = Creek trash rate during sampling period (gal/min)

$Q$  = Stream average discharge during the sampling period ( $\text{m}^3 \text{s}^{-1}$ )

$V$  = Volume of trash collected (gal)

$Q_T$  = Flow rate through the trawl, as previously calculated ( $\text{m}^3 \text{s}^{-1}$ )

$t$  = Time of the sampling period (min)

The boxplot in Figure 20 summarizes the results of calculating the trash rates for each storm and dry event. The three storm events that captured all or a portion of the rising hydrograph have noticeably higher trash rates than the five events that did not.

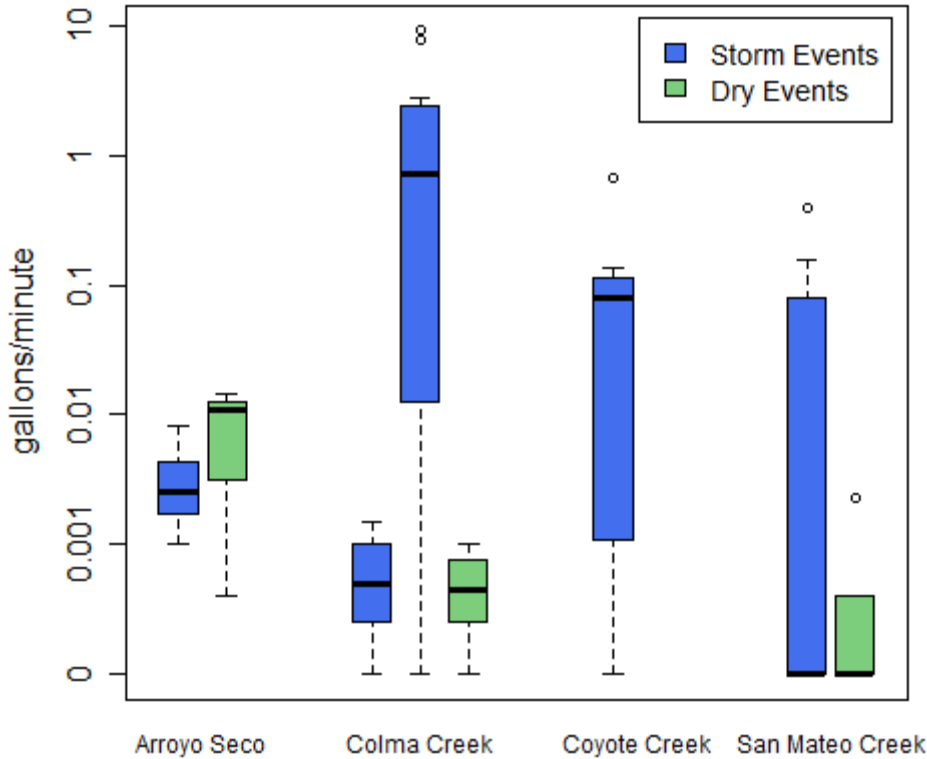

Figure 20. Boxplot of wet and dry event trash rates for each monitoring event

### 4.3.1 Colma Creek

Colma Creek (Table 8 and Figure 21) is a small-channelized creek, and responded very rapidly to the storm that occurred on November 24, 2015. Colma Creek’s flow started at 2 cubic feet per second (cfs) and increased to a peak of 149 cfs in around 25 minutes. To capture samples in the rising hydrograph, samples were taken back to back, minutes apart. The creek noticeably responded within minutes to the rainfall, going from a trickle of water to a gushing channel of water. The flashy system was expected but the creek’s quick response to the rainfall was impressive (and on the verge of shocking).

The peak velocity of the water was calculated at 0.73 meters per second, although the actual velocity where the trawl was located may have been slightly faster. This high velocity tested the limits of the trawls and the ability of the USGS Crane to handle that rapid of a flow. It is not recommended to sample in velocities higher than this. Future storm monitoring in Colma Creek may want to target more downstream locations where the channel width is much larger and therefore the velocity will be lower. Although the creek becomes tidal shortly downstream of the sampling location, it might be better and safer to measure the trash rates downstream, especially during larger storms or during low tide, where the channel would be expected to quickly push out the tidal water and become dominated by stormwater.

The “storm” event that was captured on April 7, 2015 was sampled several hours after the storm had passed, and as can be seen in Table 8, the flow was already down to baseflow conditions after a short amount of time. Both this event and the dry event had very low rates of trash. Several of the samples had quantities of trash that were at or near the measurable limit of trash for this project (5 mL).

**Table 8.** Trash Rate and discharge results for Colma Creek monitoring events

Monitoring Site	Date	Trawl Type	Time Deployed	Discharge (cfs)	Rainfall Accumulation (Inches)	Trash Rate (Gallons trash/min)
Colma-RT-01	3/4/15	Rectangular	9:34 AM	2	Dry	0.0010
Colma-MT-01	3/4/15	Manta	9:56 AM	2	Dry	0.0004
Colma-RT-02	3/4/15	Rectangular	10:31 AM	2	Dry	0.0005
Colma-MT-02	3/4/15	Manta	11:02 AM	2	Dry	0.0000
Colma-MT-01	4/7/15	Manta	9:25 AM	3	0.59	0
Colma-MT-02	4/7/15	Manta	10:25 AM	2	0.59	0.0005
Colma-RT-01	4/7/15	Rectangular	10:27 AM	2	0.59	0.0005
Colma-RT-02	4/7/15	Rectangular	11:18 AM	2	0.59	0.0015
Colma-MT-03	4/7/15	Manta	11:28 AM	2	0.59	0.0004
Colma-RT-03	4/7/15	Rectangular	12:09 PM	2	0.59	0
Colma-MT-04	4/7/15	Manta	12:22 PM	2	0.59	0
Colma-RT-01	11/24/15	Rectangular	8:39 AM	2	0.02	0
Colma-MT-01	11/24/15	Manta	9:47 AM	75	0.08	1.5323
Colma-M-HS-01	11/24/15	Mini High Speed	10:07 AM	119	0.14	2.8050
Colma-HS-01	11/24/15	High Speed	10:18 AM	91	0.20	9.0876
Colma-MT-02	11/24/15	Manta	10:41 AM	95	0.23	7.7385
Colma-M-HS-02	11/24/15	Mini High Speed	10:58 AM	37	0.23	1.9490
Colma-HS-02	11/24/15	High Speed	11:19 AM	15	0.23	0.7094
Colma-MT-03	11/24/15	Manta	11:40 AM	5	0.23	0.0846
Colma-RT-02	11/24/15	Rectangular	12 PM	2	0.23	0.0177
Colma-RT-03	11/24/15	Rectangular	12:18 PM	2	0.25	0.0074
Colma-RT-04	11/24/15	Rectangular	12:51 PM	2	0.25	0.0022

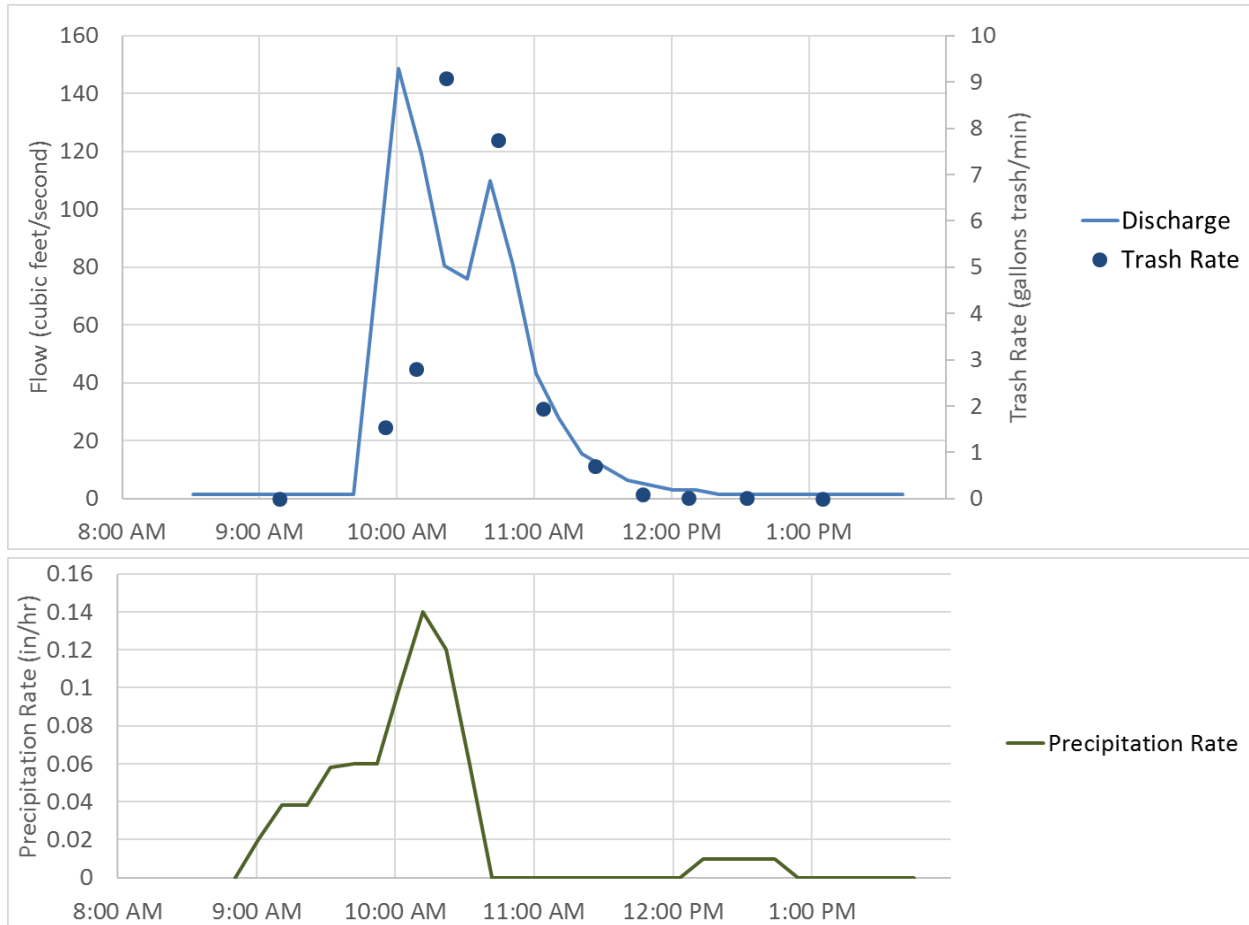

**Figure 21. Trash rates, flow, and precipitation at the event on Colma Creek November 24, 2015**

### 4.3.2 Coyote Creek

A single monitoring event occurred on Coyote Creek on May 6, 2016 (Table 9, Figure 22). Field staff noted that trash rates increased in the creek as rain increased at the site. This is consistent with what was seen at the other sites. However, Coyote Creek is a much larger system than Colma Creek and has a natural channel, much lower slope, lower stream velocities, and a portion of the expected sources of trash come from relatively far away when compared to the other three creeks monitored (Coyote Creek enters urban San Jose 10 miles to the south of the monitoring site). The creek responded very differently than the storm on Colma Creek even though both storms were relatively similar. The hydrograph in Figure 22 shows that the rain peaked around noon, and the hydrograph did not peak until nearly 7pm, seven hours later. The field team was only able from about 8:30 AM until approximately 1:30 PM, around two hours into the rising hydrograph. The field team was unable to sample further because of dangerous traffic conditions due to an incorrect traffic control plan. Ideally, the sampling would have continued at least until 7pm to capture the peak of the storm.

The trash rates observed on Coyote Creek were an order of magnitude lower than on Colma Creek. This is somewhat surprising considering the very high levels of trash easily observable along much of creek.

However, this was a very small storm, and the creek did not rise nearly as much as during larger storms, where flows of well over 100 cfs are common. Large storms would be expected to mobilize very high levels of trash in Coyote Creek.

**Table 9.** Trash Rate and discharge for Coyote Creek monitoring event

Monitoring Site	Date	Trawl Type	Time Deployed	Discharge (cfs)	Rainfall Accumulation (Inches)	Trash Rate (Gallons/min)
Coyote-BOX-01	5/6/16	Rectangular - Weighted Box	8:53 AM	2.7	0.00	0
Coyote-BOX-02	5/6/16	Rectangular - Weighted Box	10:01 AM	2.7	0.00	0.0004
Coyote-BOX-03	5/6/16	Rectangular - Weighted Box	11:05 AM	2.8	0.01	0.0018
Coyote-BOX-04	5/6/16	Rectangular - Weighted Box	12:08 PM	2.8	0.12	0.1372
Coyote-BOX-05	5/6/16	Rectangular - Weighted Box	12:30 PM	2.6	0.15	0.6639
Coyote-BOX-06	5/6/16	Rectangular - Weighted Box	12:54 PM	2.7	0.17	0.0800
Coyote-BOX-07	5/6/16	Rectangular - Weighted Box	1:20 PM	2.7	0.17	0.0921

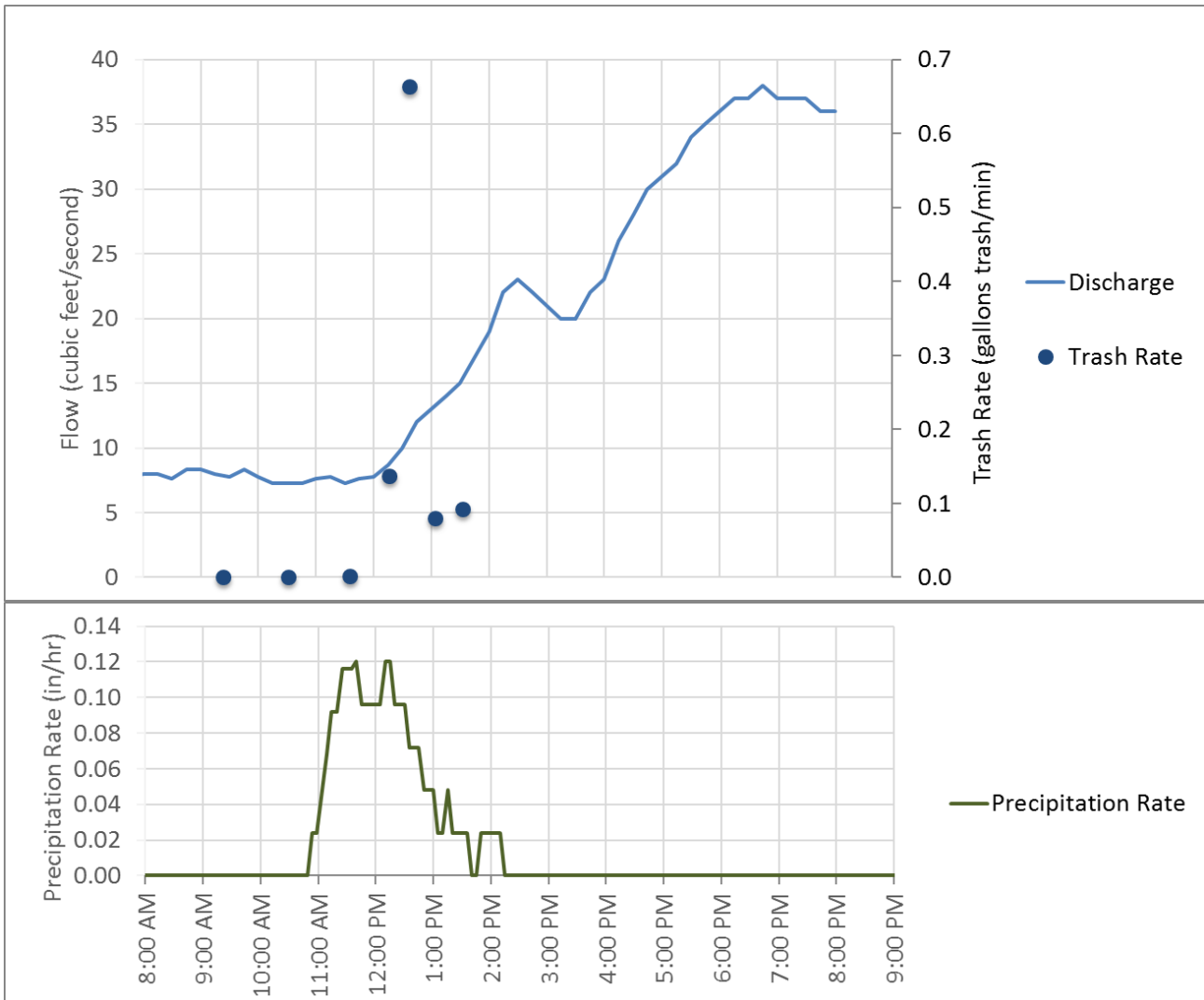

Figure 22. Trash rates, flow, and precipitation at the event on Coyote Creek May 6, 2016

### 4.3.3 San Mateo Creek

Two sampling events occurred on San Mateo Creek, a dry event on January 29, 2016 and a storm event on February 17, 2016 (Table 10 and Figure 23). San Mateo Creek is a relatively small creek with a natural channel, and a watershed that is almost entirely urbanized below Crystal Springs Dam, 4.1 miles upstream. Although urbanized, much of the watershed has low levels of trash generation, and would be expected to have much lower trash rates in a storm than Colma Creek or Coyote Creek. Unlike the channelized Colma Creek, San Mateo Creek’s flow increased at a much slower rate during the storm event, despite the rainfall being considerably heavier. The flow data in Figure 23 is for a gauge just downstream of the dam, and therefore did not capture the flow accurately at the monitoring site, which most likely had a much higher flow than shown in Figure 23. The trash rates were relatively low and in the same order of magnitude as the Coyote Creek storm, despite the full rising hydrograph being captured during the San Mateo Creek

event. This may be due to the lower trash rates and high number of trash capture devices in the watershed.

**Table 10.** Trash Rate and discharge results for San Mateo Creek monitoring events

Monitoring Site	Date	Trawl Type	Time Deployed	Discharge (cfs)	Rainfall Accumulation (Inches)	Trash Rate (Gallons trash/min)
SM-MT-01	1/29/16	Manta	9:37 AM	23	0.00	0
SM-RT-01	1/29/16	Rectangular	10:44 AM	21	0.00	0
SM-RT-02	1/29/16	Rectangular	11:53 AM	21	0.04	0
SM-MT-02	1/29/16	Manta	12:59 PM	23	0.06	0
SM-RT-03	1/29/16	Rectangular	2:06 PM	23	0.09	0.0004
SM-MT-03	1/29/16	Manta	3:14 PM	23	0.11	0.0023
SM-MT-01	2/17/16	Manta	11:27 AM	19	0.00	0
SM-RT-01	2/17/16	Rectangular	12:33 PM	19	0.00	0
SM-MT-02	2/17/16	Manta	1:38 PM	19	0.00	0
SM-RT-02	2/17/16	Rectangular	2:43 PM	19	0.00	0
SM-MT-03	2/17/16	Manta	3:48 PM	19	0.00	0.0011
SM-RT-03	2/17/16	Rectangular	4:53 PM	19	0.01	0
SM-MT-04	2/17/16	Manta	5:59 PM	23	0.17	0.1559
SM-MT-05	2/17/16	Manta	7:09 PM	26	0.35	0.3984



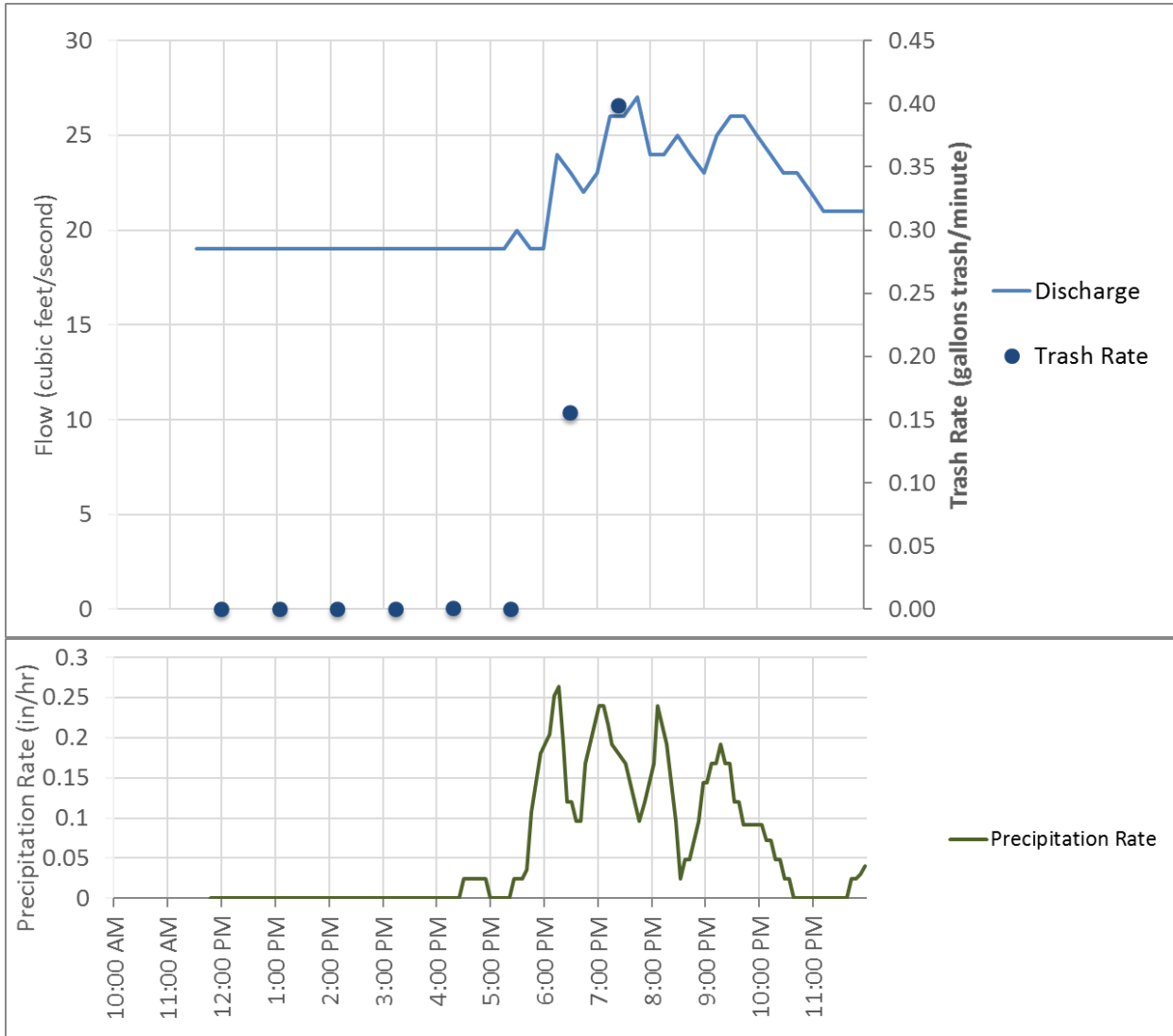

Figure 23. Trash rates, flow, and precipitation at the event on San Mateo Creek February 17, 2016

#### 4.3.4 Arroyo Seco

Two events were captured on Arroyo Seco, a storm event on March 7, 2016, and a dry event the next day on March 8, 2016 (Table 11 and Figure 24). Arroyo Seco is a concrete channel like Colma Creek, and responds very quickly to rain. The discharge data in Table 11 is not indicative to what was seen in the field. There were larger pieces of trash in Arroyo Seco but the velocity of Arroyo Seco’s inner channel was too high (3.83 m/s peak) for the equipment to safely collect samples. The high velocities are due to the channel being concrete and a relatively high slope. As seen in Figure 24, the samples did not capture the rising hydrograph, and had very low trash rates when compared to the three storm events that did capture the rising hydrograph. However, the volume of trash in the samples were similar to the Coyote Creek and San Mateo Creek storm events. The difference in trash rates is due to Coyote Creek and San Mateo Creek having much wider channels, and that the trawl was only able to capture a small portion of

those two creeks. Arroyo Seco has a narrow inner channel where all the water was flowing, and the trawls could capture the entire creek. When the volumes of trash are extrapolated to the entire creek, the trash rates on the other creeks become much larger.

**Table 11.** Trash Rate and discharge results for Arroyo Seco monitoring events

Monitoring Site	Date	Trawl Type	Time Deployed	Discharge (cfs)	Rainfall Accumulation (Inches)	Trash Rate (Gallons trash/min)
Arroyo-RT-01	3/7/16	Rectangular	12:47 PM	19	1.75	0.0025
Arroyo-RT-02	3/7/16	Rectangular	1:31 PM	17	1.75	0.0082
Arroyo-RT-03	3/7/16	Rectangular	2:07 PM	18	1.75	0.0032
Arroyo-RT-04	3/7/16	Rectangular	2:43 PM	16	1.75	0.0055
Arroyo-RT-05	3/7/16	Rectangular	3:24 PM	16	1.75	0.0017
Arroyo-RT-06	3/7/16	Rectangular	4:03 PM	16	1.75	0.0017
Arroyo-RT-07	3/7/16	Rectangular	4:38 PM	16	1.75	0.0010
Arroyo-BOX-01	3/8/16	Rectangular - Weighted Box	8:57 AM	9.8	0.02	0.0004
Arroyo-BOX-02	3/8/16	Rectangular - Weighted Box	10:08 AM	9.4	0.02	0.0009
Arroyo-MT-01	3/8/16	Manta	11:18 AM	9	0.02	0.0055
Arroyo-BOX-03	3/8/16	Rectangular - Weighted Box	11:53 AM	9	0.02	0.0109
Arroyo-BOX-04	3/8/16	Rectangular - Weighted Box	12:34 PM	8.6	0.02	0.0139
Arroyo-MT-02	3/8/16	Manta	1:14 PM	8.6	0.02	0.0145
Arroyo-MT-03	3/8/16	Manta	1:48 PM	8.6	0.02	0.0113

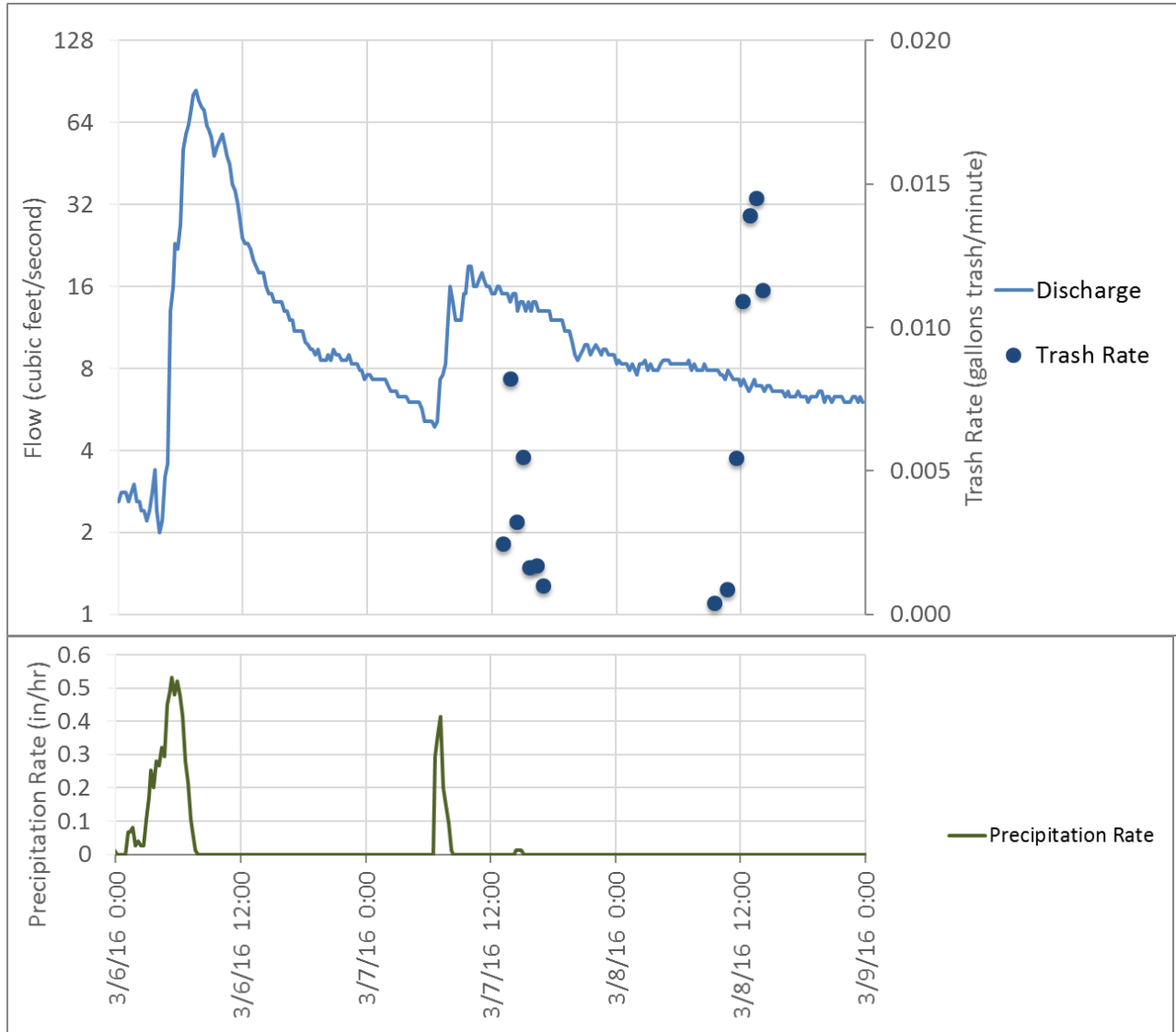
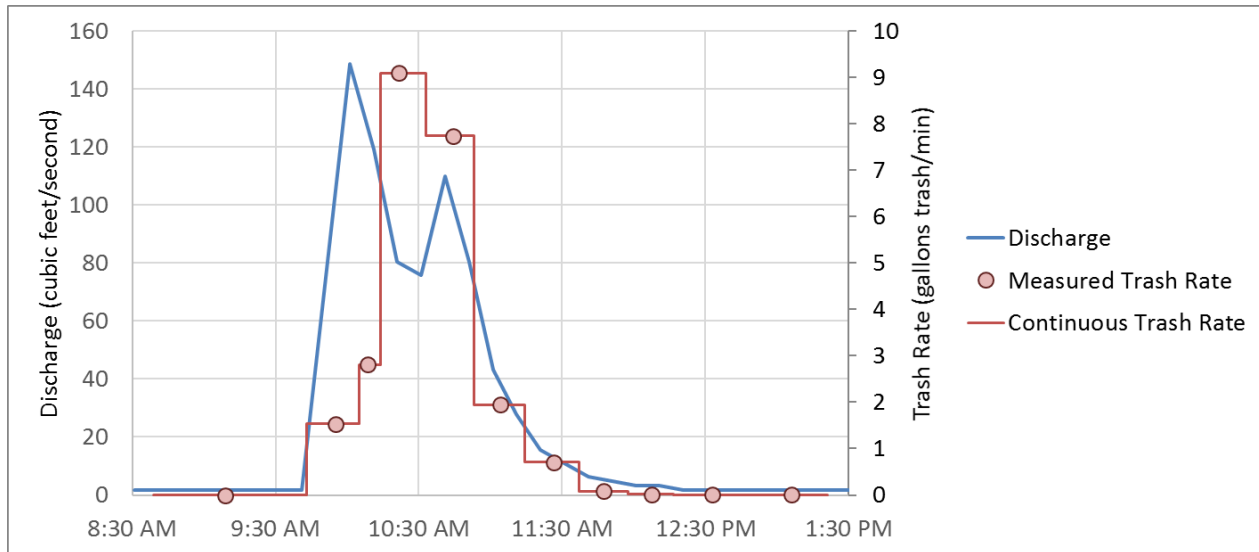

Figure 24. Trash rates, flow, and precipitation at the events on Arroyo Seco March 6-8, 2016

#### 4.4 Trash Load Estimates

Using the sample data for each sampling event, total trash loadings during the event can be calculated, although this should be considered a rough estimate, since this was not the purpose of the sampling. Samples were usually collected over a 15 to 60 minute period, although the sampling period was as short as 3 minutes for the Colma Creek storm event. There was also a 5 to 10 minute break between samples while the previous sample was being hauled up and the new trawl was being prepared and then lowered down. If the trash rates in the samples are extrapolated to these breaks, then the total trash load can be calculated from this continuous trash rates (Figure 25). For the Colma Creek storm event on November 24, 2015, the estimated load was approximately 447 gallons. The trash loading for the San Mateo Creek storm event on February 17, 2016 was approximately 24.6 gallons. The difference between these estimates is large, reflecting very different conditions between the two creeks, most likely due to higher generation

rates in the Colma Creek watershed and possibly the channelized creek is better able to transport trash. Additional research needs to be done to make any final assumptions.



**Figure 25.** Trash loading estimate method for the Colma Creek storm event November 24, 2015

#### 4.5 Variability of Trash throughout the Water Column

The TCT Project aimed to understand the variability in trash levels throughout the water column. Specifically, the project aimed to understand if trash was transported evenly throughout the water column or mainly on the water surface. Though the collection of samples throughout the water column were attempted and are possible with the Weighted Rectangular Trawl, additional research is needed to understand if there is a significant difference between what is seen on the surface and within the water column.

Visually, it appeared that high concentrations of trash were transported on the surface of the receiving water during the rain events at the sites monitored during this project, but it is difficult to see how much trash is moving within the water column. Additional research is needed to understand how much trash is transported at different levels within the water column.

Logistically, the Weighted Rectangular Trawl proved capable of collecting samples at varying depths within the water column during sampling at Arroyo Seco on March 8, 2016 and Coyote Creek on May 6, 2016. The location in the water column was noted and samples were collected with the trawl resting on the bottom of the channel and with the top of the trawl at the surface of the water. However, neither of events contained enough material to analyze whether there was a difference between samples taken on the surface versus water column. It was clear during the earlier monitoring events, sampling below the surface was difficult in high velocities, and ultimately, the bedload sampler that was projected for use on the project was not used because it required a tow truck and crane to deploy that was not allowed by the permitting agencies. The USGS Crane that was used in the project could not be used with the bedload sampler that was bought for the project because the bedload sampler was too heavy for the setup. The

project concluded that further testing with the Weighted Rectangular Trawl is needed but it will likely be able to be used to understand the distribution of trash within the water column.



**Figure 26. Weighted Rectangular Trawl after retrieval at Arroyo Seco**

It may also be possible to design a trawl that contains multiple trawls in a vertical arrangement extending from the bottom of the waterbody to the surface. This would allow the vertical stratification of trash to be compared directly during the same sampling period. However, the height of the vertical trawl would need to be appropriate for the depth of the creek being sampled. A creek such as San Mateo Creek, where the velocities are lower and the water is never more than 1.05 meters deep, may be the most appropriate type of location. Creeks with higher water velocities such as Colma Creek or Arroyo Seco may not work with such a large trawl that would exert more pull on the USGS Crane. Larger creeks such as Coyote Creek are often over two meters deep at the monitoring location during storms and would not work to sample both the bedload and surface, but may work well to sample the surface and as far down the water column as the trawl could reach.

Another factor that significantly affects the distribution of trash across the channel and in the water column is if the water is flowing in “supercritical” or “subcritical” conditions. Certain channels will reach a water velocity that will create supercritical conditions, where the water becomes much more turbulent and well mixed throughout the water column. This condition is also expected to more evenly distribute trash throughout the water column and horizontally across a channel. When the water is flowing in subcritical conditions, a stream is moving more smoothly, is less mixed, and trash most likely moves downstream more in the thalweg of the channel where velocity is the highest. Most natural rivers and creeks with lower gradients will have subcritical flow, and concrete channels and creeks with higher slopes (and therefore higher velocities), will have supercritical flow.

The flows observed in the two concrete channels included in the project, Colma Creek and Arroyo Seco, during sampling events were experiencing supercritical flows. Trash during these events was therefore likely more mixed throughout a channel. Extrapolation of a sampled trash rate to the entire water column under these conditions may therefore be appropriate. When more trash is flowing in the thalweg in

subcritical flows such as the two natural channels monitored in this project, then extrapolating to the entire water column accurately is more challenging.

## 4.6 Equipment Feasibility

All the trawls tested in the field performed adequately and collected valuable information. Table 12 describes important information for each piece of equipment, identifying positive and negative aspects related to each trawl. The peak flow was estimated by the fieldwork related to this project.

Based on fieldwork, it was clear that the USGS Crane had limitations in faster flowing waters, acting very unstable during wet weather sampling. The slope, channel characteristics, discharge, and depth all influenced the velocity of the water. Several of the trawls (Manta Trawl, High Speed Trawl and Mini High Speed Trawl) pulled on the USGS Crane at an angle causing the system to be unstable. Sampling was difficult when velocities were above 0.73 m/s seen at Colma Creek on November 24, 2015. The Manta Trawl was deployed at Arroyo Seco on March 8, 2016 at higher velocities (2.28 m/s), however the flow at the location of the sampling was very shallow (6 inches) though flowing fast. The Rectangular Trawl (and Weighted Rectangular Trawl) pulled the USGS Crane at a more vertical angle, staying more stable throughout storm monitoring.

**Table 12.** Effectiveness of trawls with USGS Crane System

Trawl Type	Fieldwork Peak Flow (m/s / knots)	Positive	Problems
Manta Trawl	2.78 m/s / 5.4 knots (Arroyo) 0.73 m/s / 1.4 knots (Colma)	(1) Performed in higher flows than anticipated; (2) scientifically proven through years of research; (3) Simple design	(1) Limited to flows less than 0.73 m/s
High Speed Trawl	0.73 m/s / 1.4 knots	(1) Worked well in high flow at Colma Creek	(1) Bulky and large trawl; (2) Small opening limiting trash from entering trawl
Mini High Speed Trawl	0.73 m/s / 1.4 knots	(1) Compact trawl; (2) less expensive	(1) Small opening limiting trash from entering trawl; (2) Some skipping because of small wingspan
Rectangular Trawl	0.07 m/s / 0.14 knots	(1) Worked well in low flow; (2) Largest trawl area of trawls tested; (3) Least Expensive	(1) Without weights, cannot be used in flows over 0.07 m/s
Weighted Rectangular Trawl	3.83 m/s / 7.4 knots	(1) Performed well with high flows, (2) Able to sample within water column at varying depths; (3) Not expensive to fabricate; (4) Additional weights may improve trawl use	(1) Swung forward with flows over 3.83 m/s

The project was unable to test the Weighted Rectangular Trawl at Colma Creek during a larger rain event, which would have been helpful in understanding if the trawl can perform and collect samples during higher flow. It performed successfully at Coyote Creek on May 6, 2016, and would likely perform better than the other trawls during high velocities. In addition, the Weighted Rectangular Trawl can be deployed at different locations within the water column, which would allow information to be collected on the distribution of trash throughout the water column.

Typically, a flowmeter is attached to each trawl to calculate real-time velocity. However, the type of flowmeter used in this project did not work well in high flows with significant amounts of natural debris, causing the flowmeter to be inconsistent. Based on these findings, the project team recommends to keep the flowmeter in the creek for a shorter amount of time while deploying it separately from the trawl. This recommendation should help prevent clogging since the flow meter will be in the water less time than the trawl. There are also other types of flow meters that may be more effective at collecting real time velocity. Therefore, water velocity of the receiving water was estimated based on discharge provided by nearby flow gauges, maintained by USGS or local agencies, and the width and depth of the river at the time of sampling. Depth changed drastically in concrete channels and it was difficult to collect depth information, but depth was estimated based on photographs and in the field. Naturally, in a river system, velocity changes throughout the water column. Assuming our samples were taken in the quickest moving section of the river, we could estimate water velocity (Table 13).

**Table 13.** Estimated velocity range for each monitoring event

Site	Channel Type	Date	Size of Rain Event (inches)	Estimated Velocity Range (m/s)
Colma Creek	Concrete Channel (small)	3/4/15	Dry	~ 0.14
		4/7/15	0.59	0.07 - 0.12
		11/24/15	0.25	0.05 - 0.73
San Mateo	Natural (small)	1/29/16	Trace	0.14 - 0.15
		2/17/16	0.45	0.11 - 0.35
Arroyo Seco	Concrete Channel (large)	3/7/16	1.75	3.23 - 3.83
		3/8/16	0.02	2.66 - 3.03
Coyote Creek	Natural (large)	5/6/16	0.17	~0.02

Water velocities ranged from 0.02 to 3.83 m/s, depending on the channel type and storm intensity. Storm intensity and rainfall played a large role in increasing water velocities in the concrete channel waterways (Colma Creek and Arroyo Seco). Colma Creek had the largest range in documented water velocities throughout the events, ranging from 0.05 m/s to 0.73 m/s. Water velocities increased to 0.73 m/s within less than half an hour after rain fall began. Compared to a similar storm at San Mateo Creek, the change in water velocity was much less, ranging from 0.11 to 0.35 m/s throughout the storm. This comparison shows that the type of receiving water, channelized or natural, and the slope of the receiving water is very important and influential on the discharge and water velocity range of each receiving water.



**Figure 27. Rectangular Trawl deployed at San Mateo Creek**

Overall, the Manta Trawl performed best in waters with a velocity less than 0.73 m/s. The Manta Trawl is limited by the size of the opening (0.16 x 0.16 m) and trash accumulated at the opening and caused the flow meter to not work correctly. The Manta Trawl performed well to collect the first flush at Colma Creek and San Mateo, showing that the Manta Trawl can perform in channelized and natural environments. The Manta barely fit in the inner channel at Arroyo Seco and it had difficulties with high flows. The project did not use the Manta Trawl at Coyote Creek because the Traffic Control Plan was not set up correctly. The Manta Trawl did not perform well in the high flows and should only be used in flows less than 0.73 m/s.

Like the Manta Trawl, the High Speed Trawl was placed on the surface in the fastest moving section of the river, which was usually the middle of the water body. At Colma Creek, the High Speed Trawl was used at 0.73 m/s velocity and the trawl performed well, although like the Manta Trawl, High Speed Trawl encountered a lot of pull on the USGS Crane during these high flows. Therefore, this trawl should not be used in situations with water flowing faster than 0.73 m/s. The High Speed Trawl was anticipated to perform better and be able to withstand higher flows at the monitoring sites, although both trawls had difficulty with the high flows at Colma Creek and Arroyo Seco. Trash also accumulated around the opening because the opening to the trawl is small (0.4 x 0.16 m). There was no clear performance difference between the High Speed and the Manta Trawl, suggesting that the Manta Trawl may be a better trawl because it is smaller and has more scientific validity.

The Mini High Speed Trawl was used at Colma Creek and performed similar to the Manta Trawl but could not withstand the higher flows. Again, similar problems seen with the Manta Trawl were noted, including trash accumulating at the mouth of the trawl and excessive pull on the USGS Crane causing tipping.



The USGS Crane was bulky and not able to withstand much pull on the system, becoming unstable during the sampling events with the higher stream velocities at Colma Creek and Arroyo Seco. The system performed adequately at San Mateo Creek and Coyote Creek. Adding weight to the USGS Crane may help limit tipping, but this was not explored. Less tipping was noted when the Rectangular and Weighted Rectangular trawls were used.

In the early fieldwork, the Rectangular Trawl did not perform well in higher flows. But once the trawl was weighted, field staff could use the Rectangular Trawl during higher flows. During fieldwork on March 9, 2016 at Arroyo Seco, the Weighted Rectangular Trawl performed well during flow as high as 3.8 m/s. The Weighted Rectangular Trawl also allows sampling at varying depths in the water column, which makes the Weighted Rectangular Trawl a good option.

## **4.7 Weather and Flow Data**

Methods to predict weather and measure flow for each sampling event followed the projected methods described in the TCT Project Sampling and Analysis Plan. Tracking weather was time consuming and difficult at times, though essential for the project to be successful. Storms are variable and weather forecasts changed from day to day, sometimes not giving much notice to the project's field team. The flow gauge data were used to determine the hydrographs for each storm event monitored. Velocities were estimated based on the discharge provided by the gauges, water depth, and channel dynamics, ranging from 0.05 to 3.83 m/s, summarized in Table 13.

## **4.8 Project Costs**

Costs were tracked throughout the project to understand the percentage of time spent on different aspects of the project. The project was broken into categories so that the percentage spent on different components of the project could be analyzed. Table 14 displays percentage of time that 5 Gyres staff and trained field staff spent on different aspects of the project.

Much more time than expected was spent on obtaining the required permits related to the project. This "Permit Prep / Discussions with Agencies" category includes all discussions directly with management and environmental agencies and time spent getting permitting requirements together. This category is also likely underestimated and a portion of the project management category should be included because a significant amount of staff time was spent discussing the permit needs. A traffic control plan was required at each site that also took more time than expected to develop and execute. Companies that specialize in traffic control plans in San Francisco and Los Angeles were hired to develop the plans and provided the required equipment for rental. To cut costs, 5 Gyres picked up all traffic control equipment and set up the equipment according to the plan at the Bay Area sites. Because the Arroyo Seco monitoring site had the most extensive traffic control plan and the offices of the traffic control company were more than 30 miles away, extra funds were spent to have the traffic control measures set up by the Traffic Control Company. Though costly, this method eases some of the responsibilities of the project managers and, most importantly, frees up space in the trucks and vans used by the project.

**Table 14.** Estimated % of time spent on different aspects of the TCT Project

Project Categories	Estimate Total Hours Spent by Project Team (5 Gyres and Field Staff)				
	2013	2014	2015	2016	%
Permit prep / Discussions with Agencies	0	50	105	35	11%
Site Visits / Equipment / Field Work	0	70	224	186	27%
Characterization	0	0	60	40	6%
Prep / Planning / Project Management	144	168	172	117	33%
Report Development (Lit Review, SAP, etc)	50	198	70	86	23%
TOTAL	194	486	631	464	100%

A consultant (Project Data Coordinator) was hired to help with data organization related to the project. It became clear that the project manager needed assistance in securing the appropriate permits and managing the data for the project. Table 15 show that the Project Data Coordinator time was spent relatively equally between monitoring sites. This was a detail that was difficult to track throughout the entire project, but because the Project Data Coordinator hours were less, we could analyze the time fraction spent on each monitoring site.

**Table 15.** Estimated hours per category for Project Data Coordinator

Project Categories	Estimate Total Hours Spent by Project Data Coordinator				
	Colma Creek	San Mateo Creek	Arroyo Seco	Coyote Creek	%
Permit prep / Discussions w Agencies	2	20	56	39	48%
Site Visits / Equipment / Field Work	16	1	1.5	1	8%
Characterization / Data Organization	34	14	4	2	22%
Prep / Planning / Project Management	8	14	5	7	14%
Report Development (Lit Review, SAP, etc)	5	5	5	5	8%
TOTAL	65	54	71.5	72	100%

Results from Table 14 and Table 15 show that more than 10% of the project's budget was spent on obtaining permits, much higher than expected. Based on the total hours spent by 5 Gyres staff and consultants, an average of more than 47 hours was spent obtaining permits for each site. In future projects, more time should be allotted for work related to obtaining permits. For the most part, time was spent working through details related to the project, mostly project design, site location, traffic control requirements and insurance needs.

Insurance requirements differ between agencies and cities and this process should be started at the beginning of any future project. These complications often took a lot of time (3+ months) to resolve. Many of the cities, counties and districts required precise insurance documentation that our carrier could not always provide even though the appropriate coverage was in place. In one case, the project was held up for over 6 months at Coyote Creek because the City of San Jose requires specific automobile insurance coverage.

Traffic Control Plans were required for each site (Appendix A). Traffic control plans took anywhere from one to six months to obtain and were generally supported if City and County guidelines were followed. We ran into some issues with trying to change locations quickly, causing us to be unable to change monitoring sites (same receiving water different location). The Traffic Control Plan issued for Coyote Creek was incorrect; however, changes were not made because traffic was too big of an issue at the site to continue fieldwork. We used local companies that specialized in developing traffic control plans. These companies work with cities and counties to assure that local traffic and construction regulations are followed. For San Mateo, where sampling occurred at a footbridge, the TCT Project team was able to work with the city to develop a traffic control plan because the site did not include rerouting traffic. Sites that are within urban parks and not on busy roads should be prioritized if possible.

Time spent on data characterization was much lower than expected, partially because related partners on the project organized and processed much of the samples. Overall, samples collected with the trawls contained less volume of material than samples collected in storm drain inlets in other portions of the TCT project, resulting in much quicker sample analysis. On average, 6 - 10 samples, sometimes more, could be characterized in a full day (8 hours) with two people.

Transporting the sampling equipment and trained personnel to our four monitoring sites was one of the largest logistical components of the project. We rented a ¾ ton cargo van (or full size truck) to bring our testing equipment to each testing location. We also needed at least 3 - 4 field staff members at each monitoring event. The field staff members who helped monitor required experience handling the equipment and were field-safety trained. It was important to have at least two people present at each event who had used the equipment before, adding another layer of complexity to the project.

For our Arroyo Seco monitoring events we transported all our testing equipment in the full-size economy truck from San Francisco to Pasadena. This was a 390-mile drive (780 miles round-trip). The logistics and costs related to shipping the equipment was not an option.

## 5. CONCLUSIONS AND INFORMATION GAPS

### 5.1 Sampling Equipment

The sampling equipment identified by the TCT SAP (Geosyntec et al. 2014) was deployed and tested throughout the project. Based on this research, the Manta Trawl and Weighted Rectangular Trawl performed the best during sampling in 2015 and 2016. The Manta Trawl performed well in flow velocities less than 0.73 m/s, while the Weighted Rectangular Trawl performed well in higher flows, over 0.73 m/s (and in low flow situations as well).

The Weighted Rectangular Trawl was used to collect samples at different levels within the water column, however, additional field testing to understand the effectiveness of using the Weighted Rectangular Trawl in higher flows is needed to fully understand the Weighted Rectangular Trawl's capabilities. The development of the Weighted Rectangular Trawl was in response to the project not being able to use the Bedload Sampler that was originally proposed to monitor the bottom of the receiving waters. The Bedload Sampler was too heavy and needed additional equipment and a tow truck for deployment, which was not supported by the regulatory agencies.

The typical flowmeter that is used with the type of trawls in the project did not collect accurate data during the project. The flowmeter was attached to top portion of each trawl (consistent with SAP protocols); however, even during consistent low flow, the wheel on the equipment did not spin consistently or during times when trash was present in the receiving water. Therefore, velocity was estimated by discharge recorded by nearby flow gauges, dimensions of the receiving water channel, and the height of the receiving water at the time of sampling. It is important to explore other methods to collect real time velocity (possibly digital flow meters or something similar) because long-term flow gauges were not always adjacent to the monitoring site. Since velocity is a function of depth and unique to each site, this relationship can be established outside of the trash sampling, possibly between trash samples. Four to five measurements at different flows should be able to determine this relationship so that a velocity measurement does not need to be taken with each sample. Water velocity can also be estimated using Manning's formula<sup>11</sup> when sites are being selected to ensure that the flow velocities are not going to exceed equipment thresholds.

The USGS Crane successfully deployed trawls during lower flows, but was not stable at higher flows (0.73 m/s). On the other hand, the USGS Crane was more successful when deploying the Weighted Rectangular Trawl at higher velocities, likely because the Weighted Rectangular Trawl is deployed directly below the USGS Crane System rather than at an angle. Adding extra weight to the USGS Crane System is essential and possibly redesigning the USGS Crane System to make it safer and simpler is recommended.

### 5.2 Monitoring Site Considerations

More than 12 potential receiving monitoring sites were analyzed in the San Francisco and Los Angeles regions. Four sites representing large, small, channelized and natural receiving waters were selected based on if they met the criteria described in Section 2.2. All the sites were evaluated through field visits and discussions with local governments to evaluate if: (1) flowing water was present during dry and wet seasons; (2) the bridgeway was wide enough to fit USGS Crane; (3) a USGS flow gauge (or other agency) collecting data at least every 30 minutes was located nearby; and (4) cities and counties were interested in

<sup>11</sup> [https://en.wikipedia.org/wiki/Manning\\_formula](https://en.wikipedia.org/wiki/Manning_formula)

partnering on the Project. Other factors that were considered were traffic in the area, extra trash inputs (like homeless encampments), and anything else that might prohibit the monitoring. Unexpected problems occurred at each site. Most importantly, traffic at Coyote Creek proved to be dangerous and the site was only monitored for one event. In addition, the Arroyo Seco site was in a section of the channel that flowed very quickly, making sampling nearly impossible during storm events.

In summary, a good monitoring site has the following characteristics:

- Expected flow velocities are less than 0.73 m/s;
- Flow Gauge is located close and is expected to have a flow similar to the monitoring site;
- Bridgeway located above receiving water that is wide enough for all equipment and less than 30-feet above the surface of the receiving water;
- Regulating agencies are willing to grant access to the site 24-hours a day and approve the research request;
- Traffic in region is limited and there is ample space next to the bridgeway where monitoring can safely be carried out.

### **5.3 Measuring Trash Rates and Loads**

The TCT Project ran into numerous issues that limited the project, including issues related to permitting and a lack of storms during project. In addition, the flow gauges included in the project did not always reflect the flow that was seen at the monitoring site. However, the TCT Project could estimate trash rates and loading throughout multiple storms and has prioritized sampling methods and research needs for future studies.

Trash loading for the 0.25-inch storm in Colma Creek on November 24, 2015 was approximately 447 gallons and the trash loading for a slightly larger 0.45-inch storm in San Mateo Creek was approximately 24.6 gallons. The difference between these estimates is large, suggesting that loads from channelized receiving waters with higher trash generation rates in the watershed may be much higher during storm events.

### **5.4 Timing and Sampling Considerations**

The samples collected throughout the small rain events at Colma Creek on November 24, 2015 and San Mateo on February 17, 2016 proved that our sampling methods were successful in determining trash trends within a single storm in receiving waters. Data showed that trash increases at the beginning of storms and the rising hydrograph, proving that it is very important for any sampling to occur during this period. Figures 20 through 22 show the relationship between trash rates and discharge within a single storm. From the research, the ideal number of samples collected during each monitoring event was not fully determined. During each wet weather event, 7 to 11 samples were collected, which were enough samples to successfully monitor a storm. It is important to understand the hydrograph of previous storms at each monitoring site to calculate the sampling frequency and duration needed to adequately capture the full rising hydrograph within the planned number of samples. It would be ideal, if funds and field staff allow, to monitor storms throughout the hydrograph to better understand rates at a site. This would be easier in smaller catchments where the hydrograph rises and fall much faster than in large waterbodies such as Coyote Creek. This project demonstrated that the timing of the samples relative to the hydrograph was more important than the number of samples collected.

The difference in velocities between natural and channelized receiving waters is also notable (and expected). In the channelized receiving waters like Colma Creek, data shows that stormwater and trash flushed through the system quickly. At San Mateo Creek and Coyote Creek, trash levels increased with flow but both flow and trash rates increased much less than on Colma Creek.

During each storm event, both discharge and trash rates increased as rainfall increased. At Colma Creek, within 30 minutes the flow was 149 cubic feet per second, starting at 2 cubic feet per second. This drastic increase was difficult to handle with the sampling system used during this project, specifically the USGS Crane system. Though the Weighted Rectangular Trawl was not used at this time, it may have been more sturdy and able to withstand the high flow. Additional information is needed to understand the full capabilities of the Weighted Rectangular Trawl. In addition, trawls were filling with trash within 3-6 minutes in some cases, suggesting that in any higher flow, the trawls may fill even quicker.

It is difficult to compare trash rates between monitoring locations based on the limited data that was collected during the project. To fully compare trash levels, multiple storms must be monitored at different times throughout the year. If possible, the first storm of the season should be monitored, which mobilizes trash that has been accumulating on the banks of creeks and in storm drains for months during the dry season. The project was unable to evaluate the *seasonal* first flush (monitoring the very first storm of the season) because of permits and logistical problems. Ideally, at least than four storm events should be monitored at each monitoring site to better understand the relationship between storm size and the length of antecedent dry weather at that site. More research is needed to fully understand the minimum number of events to establish this relationship.

Trash rates during dry weather are near zero, so future monitoring should focus on wet weather events. For this project, wet weather was defined as an event that was 0.25 inches, but sampling at Colma Creek during an event that was exactly 0.25 inches mobilized a significant amount of trash. This may mean that monitoring events of different sizes is an important aspect in understanding how storms of different sizes mobilize trash in each waterbody. In natural larger channels, such as Coyote Creek, it may be important to monitor large storms that are capable of mobilizing trash that is not mobilized during smaller events. For channelized systems, such as Colma Creek, trash may be mobilized more readily in smaller storms.

## 5.5 Resource Considerations

Many aspects of the project took longer than expected, primarily the permitting requirements and weather monitoring related to the project. Permitting was often confusing and requirements were very different depending on the cities and agencies involved. Weather and storm monitoring were time consuming and often frustrating because of the variability in the projections. The project requires extensive preplanning related to each mobilization and this is more challenging because storms can often be unpredictable and change last minute. Finding available field staff and logistics to transport equipment tended to be in the main stresses related to making the fieldwork portion for the project successful.

There were a lot of uncertainties throughout the project and many unexpected roadblocks. But the project was a success in many aspects since the project collected data that shows trash trends throughout a small storm, with the capabilities of expanding this type of research to monitor throughout an entire rainy season. High costs and time-consuming logistics are a fundamental component of this type of work and planning to accommodate this should be included.

## 6. RECOMMENDATIONS

Recommendations for this report have been grouped under the Project's Main Objectives.

*What type of sampling equipment provides for the most accurate and representative measurement of surface, water column and bedload flux in the different channel types and during different flow events?*

### **Recommendation 1: Additional testing of the Weighted Rectangular Trawl in higher flows in a channelized receiving water.**

The Weighted Rectangular Trawl proved to be the most versatile (and economical) trawl that was tested during the project. The trawl was able to collect samples at different depths throughout the water column, which was identified as a priority during project planning and by the TAC. The Weighted Rectangular Trawl was used in high flows at Arroyo Seco on March 7, 2016; however, the Weighted Rectangular Trawl has not been tested in wider channels such as Colma Creek. Colma Creek is a monitoring site that is easy to access and would be an ideal site to test the Weighted Rectangular Trawl with the USGS Crane, possibly using additional weights added to the USGS Crane to further prevent tipping (See Recommendation 3).

### **Recommendation 2: Collect Real Time Velocity during Sampling**

The flowmeter that is typically used with the trawls in this project did not perform well during low flows or during times of high flows. The flowmeter's wheel did not spin consistently and trash and debris blocked the wheel from spinning. Other flowmeters that should be explored that can possibly collect flow data with more confidence. Flowmeters that are attached to poles and flowmeters that can be installed under bridgeways should be explored and used in future studies. Also, the water velocity does not need to be measured during each sample if a relationship between velocity and flow or water depth is established.

### **Recommendation 3: Improve USGS Crane for Safety and Ease**

The project used a USGS Type A Crane with Four-Wheel Truck Model 4350 (USGS Crane) (Figure 7) to deploy four different trawls successfully off of bridgeways; however, the USGS Crane is very difficult to set up and can be unsafe during sampling at higher flow velocities. Problems with crane stability were encountered in multiple monitoring events in flows as low as 19 cubic feet per second with the Manta and high speed trawls. The rectangular trawl pulls on the USGS Crane system differently and was more stable. Either way, the crane system should be designed in a way that it is safer to use during higher flows.

Based on the fieldwork of this project, 5 Gyres Research Director Marcus Eriksen suggests a new Bridge Boom System that is easier to use, safer and will work better in higher flows (Figure 28). When using a trawl that may float horizontally downstream in different water velocities, there is a need for a more versatile boom that has more control of trawls that pull with variable force and angles. The new proposed device uses a sailing winch and line to control the release and recovery of trawls. Lines are locked down with cleats and blocks. All the equipment would be familiar to any sailor, and is already designed for safety and efficiency, eliminating exposed cables and pinch spots. The base of the proposed Bridge Boom System is a 3-foot by 3-foot platform on wheels that can be locked in place. From this platform, an 8-foot long arm with two angles (each 45 degrees) would allow the arm to extend 90 degrees over the side of a bridge. There are blocks (similar to pulleys) at each angle and at each end. At the base, opposite of the bridge edge, there are at least 100 pounds of lead weights.

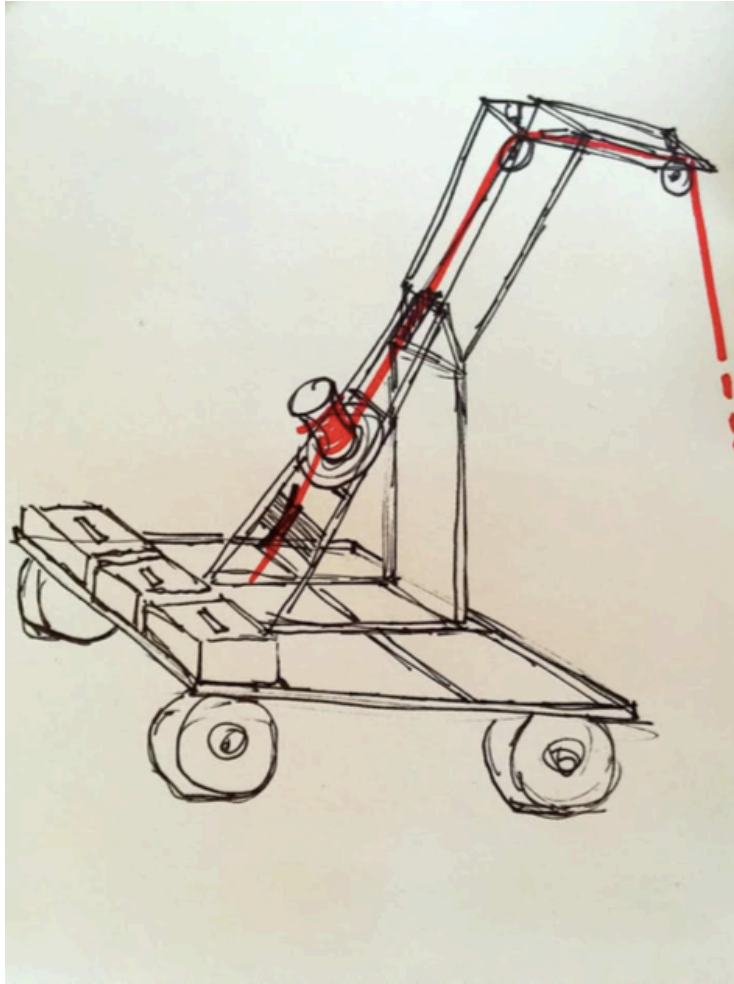

**Figure 28. Sketch of suggested improved boom truck with crane and weights**

**Recommendation 4: Explore Innovative Techniques to Monitor Trash in Receiving Waters**

It is clear that sampling from bridgeways is possible but quite expensive and time consuming leading to the need to explore new innovative techniques to monitor trash. As a result, it may be beneficial to monitor at the mouth of the receiving water using a boat and Manta Trawl, mimicking the protocols that have been scientifically vetted to measure plastic pollution in our oceans. This would be done by renting a small vessel and sampling with the manta trawl near the mouth of the selected receiving water. This would eliminate some of the logistical limitations determined by the project related to equipment, permitting, and traffic control requirements.

Other innovative techniques have been discussed, such as the use of submersibles and remote sensing. Any of these types of techniques would be very expensive but possibly something the tech community would be interested in exploring.

The concept of using a pump system has been discussed by several partners. This concept is more supported by scientists sampling microplastics in aquatic environments but should be further explored to monitor a larger size fraction.



*What is the variability in trash loading within and among storms, and is there a first flush effect (seasonally and during each storm)?*

**Recommendation 5: Monitor a small Receiving Water over an Entire Wet Weather Season**

The project concluded that monitoring small rain events is possible and can mobilize trash into receiving waters. The project confirmed that to monitor trash flux loading, it is essential to monitor the beginning of each storm and the entire rising hydrograph. This means that being in the field before rain begins is essential, along with monitoring through the first few hours of the storm. Depending on the creek, the first 30 minutes of a storm will mobilize significant amounts of trash, although in large systems such as Coyote Creek, some trash may take hours to reach the monitoring site. Hydrographs of previous storms should be viewed at each monitoring site to understand the length of time of the rising hydrograph to ensure that the targeted number of samples are collected. Although the first seasonal storm was not monitored, it is expected to mobilize significant amounts of trash that has been accumulating during the dry season.

To understand how trash loading varies between storms and throughout the rainy season, it is recommended to monitor a single receiving water throughout multiple rain events in one season. If possible, 4-5 (or more) storm events varying in size and differing antecedent dry periods should be monitored.

**Recommendation 6: Broaden Sample Characterization Techniques**

The characterization protocols used to analyze the trash collected during this project should be re-evaluated and expanded to assure that other entities that are also working on plastic pollution and trash projects in the region can use any data that is collected through similar projects. For example, many studies are interested in total number of plastic items found in the samples.

*How much time and resources are required to do the receiving water assessment (sample collection and characterization)?*

**Recommendation 7: Partner with Existing Projects that Routinely Monitor Pollutant**

Storm tracking proved to be very time consuming and could be relieved by partnering with groups that are already tracking storm events. Several system-wide monitoring efforts are in place to monitor pollutants in the Bay Area and Southern California that already require storm tracking. San Francisco Estuary Institute (SFEI) and Southern California Coastal Water Research Project (SCCWRP) are two organizations that monitor extensively and would be good resources for assisting with some aspects of the project, including fieldwork and storm tracking.

Furthermore, it is necessary to fully train field staff before sampling begins. Partnering with agencies with sampling experience such as SFEI and SCCWRP may assist in this training.

**Recommendation 8: Plan for Additional Costs and Time Related to Permitting Requirements**

Costs related to assembling permit applications and working with entities to understand project limitations should be incorporated into project planning and projections. All of the cities, counties and entities involved in the project were willing to work with our project manager to make the project happen, however, this took longer than expected. When planning for the project, details related to permitting requirements should begin at least 9 months (or more) prior to the start of the project.

## 7. REFERENCES

- Applied Marine Sciences, Inc. 2014. BASMAA Tracking California's Trash Quality Assurance Project Plan. October 2014.
- Baldwin, A. K., Corsi, S. R., & Mason, S. A. 2016. Plastic debris in 29 Great Lakes tributaries: relations to watershed attributes and hydrology. *Environmental Science & Technology*, 50(19), 10377-10385. <http://pubs.acs.org/doi/ipdf/10.1021/acs.est.6b02917>
- EOA, Inc. and 5 Gyres, 2014. BASMAA Tracking California's Trash Project Literature Review. October 2014.
- Eriksen, M., Lebreton, L., Carson, H., Thiel, M., Moore, C., Borrorro, J., Galgani, F., Ryan, P., and Reisser, 2014. Plastic pollution in the world's oceans: more than 5 trillion plastic pieces weighing over 250,000 tons afloat at sea. *PLoS ONE* 9 (12): e111913. <http://journals.plos.org/plosone/article?id=10.1371/journal.pone.0111913>
- Geosyntec Consultants and EOA, Inc., 2014. BASMAA Tracking California's Trash Project Monitoring Plan. April 15, 2014.
- Geosyntec Consultants, EOA, Inc., and 5 Gyres, 2014. BASMAA Tracking California's Trash Project Sampling and Analysis Plan
- Lippiatt, S., Opfer, S., and Arthur, C. 2013. Marine Debris Monitoring and Assessment. NOAA Technical Memorandum NOS-OR&R-46.
- Moore CJ., Lattin GL., Zellers AF. 2011. Quantity and type of plastic debris flowing from two urban rivers to coastal waters and beaches of Southern California. *J. Integr. Coast. Zone Manag.*, 11 (2011), pp. 65–73
- Sutton, R., Mason, S.A., Stanek, S.K., Willis-Norton, E., Wren, I.F., Box, C., 2016. Microplastic contamination in the San Francisco Bay, California, USA. *Marine Pollution Bulletin* 109 (2016), 230-235.
- Yonkos, L. T., Friedel, E. A., Perez-Reyes, A. C., Ghosal, S., & Arthur, C. D. 2014. Microplastics in four estuarine rivers in the Chesapeake Bay, USA. *Environmental science & technology*, 48(24), 14195-14202.

## **Appendix A**

### Permits and Traffic Control Plans

## **Appendix B**

### Characterization Data and Field Sheets

## **Appendix C**

### Data Quality Assurance Evaluation

## **Appendix D**

### Additional Photographs